

Making Inroads: Chinese Infrastructure Investment in ASEAN and Beyond

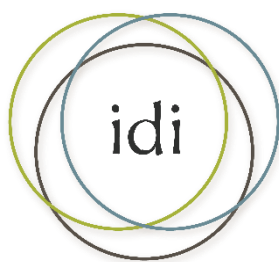

inclusive
development
international

Making Inroads: Chinese Infrastructure Investment in ASEAN and Beyond

Published by Inclusive Development International in 2016.

50 S French Broad Avenue, Suite 257
Asheville, NC 28801
USA
Email: info@inclusivedevelopment.net
Twitter: @inclusivedevt

Download this and other Inclusive Development International publications at:
www.inclusivedevelopment.net/resources/publications/



Apart from the exceptions listed below, this publication is licensed under [Creative Commons Attribution-NonCommercial-ShareAlike 4.0 International License](https://creativecommons.org/licenses/by-nc-sa/4.0/).

Front cover image: Sinohydro's Kamchay Dam, Cambodia, by Inclusive Development International.

Back cover image: Drmno lignite mine, supplying the planned China Eximbank-financed Kostolac coal-fired plant, Serbia, by CEE Bankwatch Network.

Illustration on page 15: From China Daily, February 2012, by Li Men.

Image on page 17: China Eximbank financed Kostalec B2 coal-fired plant, Serbia, by CEE Bankwatch Network.

Illustration on page 21: From Politiken, March 2015, by Anne-Marie Steen Petersen.

Image on page 25: From South China Morning Post, 2015.

Map on page 35: From China Daily, 2015, by Liu Lunan.

Map on page 36: By HKTDC Research, 2015.

Image on page 55: Stanari Coal Project, by Friends of the Earth US

Image on page 60: Sinohydro's Kamchay Dam, Cambodia, by Inclusive Development International.

Image on page 69: Artisinal mining near Wanbao operated mines, Monywa, Myanmar by Xie Wenhong

Inclusive Development International (IDI) is a human rights organization working to make the international economic system more just and inclusive. IDI supports and builds the capacity of grassroots organizations and affected communities to defend their land and human rights in the face of harmful trade, development and investment projects. Through research, casework and policy advocacy, IDI works to strengthen the human rights regulation and accountability of corporations, financial institutions and development agencies.

IDI would like to thank Katharine Lu (Friends of the Earth US) and Wawa Wang (CEE Bankwatch Network) for reviewing and commenting on this publication. Many others also provided support and advice during the process of researching and developing this paper, for which we are very grateful. We would also like to thank our partners from Cambodia, Myanmar, Thailand and China who joined the workshop in November 2015 at which the initial research findings were presented. The valuable discussion and feedback received during this workshop was integrated into the final draft of this paper.

The research and development of this publication was supported by:



THE MCKNIGHT FOUNDATION



Contents

List of Abbreviations	4
Executive Summary	5
Introduction	10
Background: The Evolving Role of China in Global Finance	12
Lack of Representation of Emerging Economies at Established IFIs.....	12
Frustrations Regarding Efficiency of Existing International Financial Institutions .	13
Global Demand for Infrastructure Finance.....	13
China’s Increasing Importance as Global Developer, Investor and Financier.....	14
Slowdown of the Chinese Economy and Domestic Overcapacity.....	16
The Asian Infrastructure Investment Bank	18
AIIB Membership	20
Sectoral Focus and Approach of the AIIB.....	22
Shareholding and Voting Powers.....	24
Structure and Management of the AIIB.....	25
AIIB Commitments to Transparency and Anti-Corruption	27
Environmental and Social Safeguards.....	28
Interaction Between AIIB and Other Financial Institutions	31
The One Belt One Road Initiative	34
What is One Belt One Road?	34
Motivations for Establishing One Belt One Road.....	37
Management of One Belt One Road.....	38
Environmental and Social Safeguards Attached to One Belt One Road.....	39
One Belt One Road Projects and the ASEAN Region	40
Financing for Projects Within the One Belt One Road	41
Chinese Investment Funds Operating in the ASEAN Region	46
The Silk Road Fund.....	46
Silk Road Fund Environmental and Social Standards	47
China-ASEAN Investment Cooperation Fund.....	50
China-ASEAN Investment Cooperation Fund’s Environmental and Social Standards.....	53

China’s Policy Banks: Financiers of the Going Out Strategy	56
China Development Bank	56
China Development Bank Environmental and Social Standards.....	57
Export-Import Bank of China	58
Eximbank Environmental and Social Standards	59
Implications for Infrastructure Financing in the ASEAN Region	61
Increased Access to Infrastructure Financing: New Risks or New Opportunities? ..	61
Social and Environmental Standards of Chinese Financiers	62
The Response of Other Nations and Institutions	63
The Development of China’s Role in the ASEAN Region	64
The Growth of Chinese Overseas Finance and Investment: Opportunities for Civil Society to Respond	66

List of Abbreviations

ADB	Asian Development Bank
AIIB	Asian Infrastructure Investment Bank
AOA	AIIB Articles of Agreement
ASEAN	Association of Southeast Asian Nations
BRICS	Brazil, Russia, India, China and South Africa
DfID	Department for International Development (United Kingdom)
E&S	Environmental and Social
EBRD	European Bank for Reconstruction and Development
ESF	Environmental and Social Framework
Eximbank	Export-Import Bank of China
FPIC	Free, Prior and Informed Consent
FPICon	Free, Prior and Informed Consultation
IFC	International Finance Corporation (World Bank Group)
OBOR	One Belt One Road

Executive Summary

Over the past decade, China has risen to become a major actor in global investment and finance. This has been made possible due to strong backing from the Chinese state and financing from its policy and commercial banks. China's role in global finance has been boosted by a number of major recent developments, the most high-profile being the establishment of the multilateral Asian Infrastructure Investment Bank (AIIB). China has also established various investment funds in recent years, such as the Silk Road Fund, and has injected additional capital into its policy banks specifically to support overseas operations. In addition, through the One Belt One Road initiative, announced in 2013, the Chinese government has renewed its support for outbound investment. These new institutions and initiatives focus heavily on infrastructure development. Given Southeast Asia's economic and strategic importance to China, and its geographical proximity, the region features strongly in China's plans for expanding overseas infrastructure financing.

The Asian Infrastructure Investment Bank

The establishment of the AIIB represents the biggest shake-up of global multilateral development finance for decades. As of mid-2016, 57 countries have signed on as prospective founding members. The AIIB's initial authorized capital is US\$100 billion. China holds the largest number of shares, roughly 30%, and controls over 26% of the voting share. The bank will focus on financing infrastructure and "other productive sectors" in Asia, with the aim of fostering sustainable economic development, creating wealth and improving infrastructure connectivity in Asia.¹ The bank announced its first batch of projects in April and May 2016.

The bank's management is likely to have much greater authority to approve projects than those at international financial institutions such as the World Bank or Asian Development Bank, whose boards provide oversight of such decisions.² The bank's president, Jin Liqun, has stressed the AIIB's commitment to being "clean" and has committed to developing a strong institutional culture based on ethical standards, with zero tolerance for corruption.³ In 2015, the AIIB organized consultations with public and private institutions on the development of its environmental and social framework, although civil society groups were critical of this brief process. The bank adopted the framework in 2016 along with an interim public information policy, corporate procurement policy and code of conduct.

The environmental and social framework was developed by a team including former World Bank safeguards specialists and draws on the standards of the World Bank and the Asian Development Bank. In early 2016, the bank adopted the framework, which commits it to pursuing sustainable projects, protecting the vulnerable and ensuring stakeholder engagement. However, the framework contains a number of

¹ AIIB (2015), *Articles of Agreement*, article 1.

² Donnan, S. & Sevastopulo, D. (2015, 25 October), *AIIB head vows to be clean, lean and green — and fast*, Financial Times. <http://www.ft.com/cms/s/0/b6f95846-7b0d-11e5-a1fe-567b37f80b64.html> (accessed May 2016).

³ AIIB (2015, 26 August), *Statement by Jin Liqun at a Press Conference in Tbilisi*. http://www.aiib.org/html/2015/NEWS_0826/16.html (accessed May 2016).

shortcomings and gaps, and the standards on resettlement and indigenous people both fall below best practice and international human rights standards.

China has been eager to emphasize that the AIIB will complement the work of existing multilateral financial institutions rather than act as a competitor. In 2016, the AIIB signed cooperation agreements with the World Bank, Asian Development Bank, European Investment Bank, and the European Bank for Reconstruction and Development, and various other institutions have indicated that they are willing to work with the bank in the future. Importantly, in cases where the AIIB co-finances projects with the World Bank, Asian Development Bank and similar institutions, the social and environmental standards or safeguard policies of those institutions are likely to apply. Co-financing with the World Bank or the Asian Development Bank is also likely to mean that if people are harmed by a project, they can file a complaint to the accountability mechanisms of these established institutions.

The One Belt One Road Initiative

A major initiative that has emerged from China in recent years is the One Belt One Road initiative. Announced in 2013, the initiative seeks to increase interconnectivity between China and Asia, the Middle East, Africa and Europe through the development of transport, energy, trade and communications infrastructure. One Belt One Road promotes investment and cooperation in multiple areas, including agriculture, forestry and fisheries, and energy.⁴ Rather than being a concrete plan or single financing facility, One Belt One Road sets out an overall vision for China's investment in the coming years. The Chinese government has stated that more than 60 countries are involved in the initiative.

China has emphasized the mutual benefits of One Belt One Road and the potential for increased cooperation and investment to benefit countries with underdeveloped infrastructure. The initiative acts as a roadmap for both facilitating China's integration into the global economy and increasing its economic influence within these regions. Many of the countries along this route already have close trade and investment links with China, and the initiative will likely support the deepening of these ties. The One Belt One Road vision stresses the importance of southwest China as a gateway to both the land and oceanic Silk Road routes, including through Myanmar, Laos and Vietnam, as part of a "pivot of China's opening-up to South and Southeast Asia."⁵

Projects within One Belt One Road will require billions of dollars in the coming years. Financing will come from a number of sources, many of which are not new. For example, China's policy banks, including the China Development Bank, have been financing projects within what is now the One Belt One Road route for over a decade. China's commercial banks are also active in many countries along the route, as are Chinese equity funds and investment companies. Several of these entities have established new funds and received additional state funding specifically to support

⁴ National Development and Reform Commission, Ministry of Foreign Affairs & Ministry of Commerce of the People's Republic of China (2015), *Vision and Actions on Jointly Building Silk Road Economic Belt and 21st-Century Maritime Silk Road*.

http://en.ndrc.gov.cn/newsrelease/201503/t20150330_669367.html (accessed May 2016).

⁵ *Ibid.*

One Belt One Road projects, and the AIIB is likely to finance projects within the initiative's route.

State-Backed Investment Funds

Another important source of financing for China's overseas investment are state-backed investment funds. Two such investment funds operating within the Association of Southeast Asian Nations (ASEAN) region are the China-ASEAN Infrastructure Investment Fund and the newly established Silk Road Fund, both of which have plans to expand operations in the coming years.

The US\$40 billion Silk Road Fund was established in 2014, with the objective of promoting "common development and prosperity of China and other countries and regions involved in the Belt and Road Initiative."⁶ The fund emphasizes investments in major infrastructure projects and connectivity. The Silk Road Fund states that it strives to promote environmentally friendly and sustainable development, and "respects international standards and norms, and follows the laws and regulations of China and the host countries."⁷ However, it is unclear what, if any, systems are in place regarding social and environmental impact assessments and mitigation in projects that it invests in.

The China-ASEAN Investment Cooperation Fund was established in 2013 and targets investments in infrastructure, energy and natural resources in ASEAN countries.⁸ It was established with an initial US\$1 billion but has a target of US\$10 billion. The China Export-Import Bank (Eximbank) led the formation of the fund and was the main sponsor, contributing US\$300 million of its starting capital. The World Bank's International Finance Corporation holds equity in the fund and contributed US\$100 million, or 10% of its phase one funding.⁹ During this first phase, the fund invested in 11 projects, including telecoms, mining, transport and energy. China aims to raise US\$3 billion for the fund's second phase.¹⁰

The China-ASEAN Investment Cooperation Fund states that it "specializes in sustainable investments that not only bring financial growth to the investee company but also significant values to the community."¹¹ In July 2014, the fund issued its Social Responsibility and Environmental Protection Guidelines for Investments in the ASEAN Region, which adopts the International Finance Corporation's Performance Standards.

⁶ Silk Road Fund (2015), *About Us*. <http://www.silkroadfund.com.cn/enweb/23775/23767/index.html> (accessed May 2016).

⁷ Silk Road Fund (2015), *Scope of Investment Principles*. <http://www.silkroadfund.com.cn/enweb/23798/23805/index.html> (accessed May 2016).

⁸ China-ASEAN Investment Cooperation Fund, *About CAF: Mission & Vision*. <http://www.china-asean-fund.com/about-caf.php?slider1=1> (accessed May 2016).

⁹ International Finance Corporation (2010, 25 January), *China-ASEAN Fund on Investment Cooperation: Summary of Proposed Investment*. <http://ifcext.ifc.org/ifcext/spiwebsite1.nsf/0/EA30D66D3BCEE0F9852576BA000E3309> (accessed May 2016).

¹⁰ Li, K. (2015, 13 November), *Remarks by H.E. Li Keqiang Premier of the State Council of the People's Republic of China At the 17th ASEAN-China Summit*, Ministry of Foreign Affairs of the People's Republic of China. http://www.fmprc.gov.cn/mfa_eng/zxxx_662805/t1212266.shtml (accessed November 2015).

¹¹ China-ASEAN Investment Cooperation Fund, *About CAF: Background*. <http://www.china-asean-fund.com/about-caf.php?slider1=2> (accessed November 2015).

All companies and projects that receive investment from the fund are required to apply the guidelines. The adoption and publication of the fund's guidelines represent a step forward in social and environmental governance that no other Chinese-led funds have taken to date. Although the fund has not established a complaints mechanism, the International Finance Corporation's 10% stake means complaints may be submitted to its accountability mechanism, the Compliance Advisor Ombudsman, although this has not happened to date.

China's Policy Banks

This paper for the most part examines recent and ongoing developments in Chinese outbound infrastructure finance. However, China's policy banks have been operating overseas for more than a decade in support of the Going Out strategy. Through this strategy, the Chinese state has promoted Chinese companies to expand overseas, utilizing surplus foreign exchange in order to increase access to global markets, natural resources and technology. The China Development Bank and the China Eximbank in particular have been major drivers of this strategy, investing billions of dollars overseas. Since the announcement of the One Belt One Road initiative, the Chinese government has injected significant amounts of additional capital into both banks.

Both the China Development Bank and China Eximbank have environmental and social standards. The China Development Bank's policies have never been published, but China Eximbank has released a basic environmental assessment policy, which applies to domestic and overseas projects. Both banks have the power to issue warnings to clients that do not appropriately manage environmental and social risks in their projects. However, neither bank publishes detailed project information, and assessments are not conducted in an open and transparent way. There are also no formal avenues through which affected people can make complaints. This lack of transparency greatly limits the effectiveness of the social and environmental policies that are currently in place at both banks.

Implications for Infrastructure Financing in the ASEAN Region

Asia faces a significant shortfall in funding for infrastructure projects. Most ASEAN governments are clearly eager to attract investment in large-scale infrastructure projects, especially in transport, energy and other projects that facilitate interconnectivity. The AIIB and other initiatives discussed here can contribute to addressing this need. It remains to be seen if the AIIB will take on projects deemed too high-risk by other international financial institutions. The fact that most of the AIIB's initial projects will be co-financed may reduce this risk, at least in the short term. However, the One Belt One Road initiative is already connected to a number of high-risk mega-projects and various fossil fuel investments in Asia.

Since the formation of the AIIB was announced, there has been much discussion about it becoming a rival to the established development finance order. However, it will take time for the AIIB to establish itself and build momentum. Existing international financial institutions have publicly welcomed the AIIB and will co-finance several of its early projects. This provides opportunities for the AIIB to learn from their safeguards and accountability systems. It also represents a potential entry point for civil society

groups in the ASEAN region and beyond to engage the AIIB through existing channels and communication networks.

The China-ASEAN Investment Cooperation Fund has adopted policies based on the International Finance Corporation's Performance Standards, and the AIIB has adopted its Environmental and Social Framework, with a grievance mechanism currently under development. However, the social and environmental safeguards of Chinese financiers are generally basic and not open to public view and scrutiny. None of the bilateral financiers discussed in this paper publish extensive project documentation, and none have grievance or accountability mechanisms in place. Given this context, and the fact that the AIIB's safeguard mechanisms remain untested, any increase in infrastructure lending in the region will require close monitoring.

Conclusion

China already plays a major role in the development of transport, energy and telecommunications infrastructure in Southeast Asia. China is the top investor in Cambodia, Laos and Myanmar, while investment in Vietnam, Thailand, Malaysia and Indonesia is also significant and increasing. All 10 ASEAN nations signed on as members of the AIIB, and the region also lies within the One Belt One Road initiative. This increased access to infrastructure financing is likely to have significant impact across the ASEAN region.

The institutions and initiatives discussed here could potentially prompt a massive influx of capital into the region, supporting a more rapid roll-out of regional infrastructure investment plans, and contributing to enhanced connectivity between China and ASEAN as well as among ASEAN member states. At the same time, without adequate transparency, safeguards and oversight, the benefits may be diminished by adverse impacts on people and the environment. Civil society groups can play an important role in monitoring and engaging with these new developments. This is not an easy task, but by developing a deeper understanding of these institutions and initiatives, monitoring their development and activities, and raising public awareness, civil society groups in the region will be better placed to push for more robust social and environmental standards and for increased accountability and protections for the communities and ecosystems that they impact upon.

Introduction

Little more than a decade ago, China was a relatively minor actor in global investment and finance. By 2014 China had become the second largest global investor, second only to the United States.¹² Outbound investment has been made possible due to strong backing from the Chinese state and financing from its policy and commercial banks. China has become a more influential player within international financial institutions such as the World Bank and the Asian Development Bank. However, it has also grown increasingly frustrated with the dominance of developed nations and the limited role of emerging economies within the management and direction of these institutions. In response, China has promoted the establishment of new institutions and initiatives, including the multilateral Asian Infrastructure Investment Bank (AIIB). China has also established investment funds such as the Silk Road Fund to provide further capital to outbound investment. These new institutions and initiatives focus for the most part on infrastructure development.

Across the world, many developing nations face an infrastructure deficit. Inadequate infrastructure has both social and economic impacts. For example, weak transport links, limited power supply, and lack of access to irrigation all impact on the daily lives of some of the world's poorest people. According to the World Bank, 1.2 billion people live without electricity; 1 billion people live over two kilometres away from an all-weather road; and at least 748 million people lack access to safe drinking water.¹³ While infrastructure is lacking in many countries, population growth means that demand continues to increase. Limited infrastructure can also create barriers to the development of industry, which can help catalyse economic development and contribute to lifting people out of poverty. China's remarkable domestic growth was fuelled by infrastructure investment, and as its role in overseas investment and finance has developed, China has also become a key actor in global infrastructure development.

China's overseas investment has increased rapidly over the last ten years. According to statistics from China's Ministry of Commerce, mainland China's outbound investment flows reached a record high of over US\$123 billion in 2014. This is over 45 times higher than in 2002, when overseas investment was just US\$2.7 billion.¹⁴ This investment flows to various sectors, including infrastructure development, and China plays a major role in the development of transport, energy and telecommunications infrastructure in Southeast Asia. Cambodia, Laos and Myanmar have all gone to great lengths to attract foreign investment, and China is now the top investor in all three countries. Chinese investment in Vietnam, Thailand, Indonesia and Malaysia is also significant and increasing.

All Association of Southeast Asian Nations (ASEAN) countries are members of the newly established AIIB, and the region also lies within the route of China's One Belt

¹² UNCTAD (2014), *UNCTADstat*. <http://unctad.org/en/Pages/Statistics.aspx> (accessed May 2016).

¹³ World Bank (2014, 17 November), *Public-Private Partnerships: Global Infrastructure Facility (GIF)*, <http://www.worldbank.org/en/topic/publicprivatepartnerships/brief/global-infrastructure-facility-gif> (accessed May 2016).

¹⁴ Ministry of Commerce of the People's Republic of China, National Bureau of Statistics of China & State Administration of Foreign Exchange (2015), *2014 Statistical Bulletin of China's Outward Foreign Direct Investment*, Beijing: China Statistics Press, p.88.

One Road, an initiative announced by Xi Jinping in 2013 that seeks to promote and enhance interconnectivity and cooperation between China and over 60 countries en route to Europe. Following the announcement of this initiative, the Chinese state has made a revitalized push to promote outbound investment, focusing especially on infrastructure and connectivity. In addition, China has launched several multibillion-dollar investment funds targeting overseas investments.

This renewed push from China is likely to have a significant impact on the availability of financing for large-scale infrastructure projects in Asia. At the same time, the emergence of new multilateral banks, and in particular the AIIB, creates an environment in which, for the first time, emerging economies have a leading voice regarding governance and management decisions in a major international financial institution. As a result, the landscape of both regional and global development finance and investment is likely to change significantly in the coming years. There has been much discussion and speculation about the potential impact of the new institutions and initiatives, especially regarding the social and environmental standards that will apply to their operations.

This study examines this rapidly evolving landscape and its potential implications. It focuses on the ASEAN region, and draws examples particularly from the lower Mekong countries. However, it will also be of value to individuals and groups elsewhere in Asia and internationally who are monitoring these developments. The main focus is on the formation of the AIIB and the implementation of the One Belt One Road initiative. The paper also looks at other Chinese financial institutions, including policy banks and investment funds, assessing the potential impact they are likely to have in the region and beyond as Chinese outbound investment continues to grow.

The aim of this study is to increase civil society awareness of these institutions and initiatives, how they will potentially impact on local communities and the environment in the areas where they work, and what environmental and social standards and governance systems that they have adopted. The paper concludes by exploring strategies that civil society could deploy to respond to these developments and influence the policies, projects and operations of Chinese-led finance institutions.

Background: The Evolving Role of China in Global Finance

The year 2014 was significant for international development finance. At their sixth annual summit, the BRICS nations (Brazil, Russia, India, China and South Africa) announced the formation of the New Development Bank. This jointly controlled institution was formally established in 2015 with an initial approved capital of US\$50 billion and plans to fund infrastructure and “sustainable development” projects in member nations. China also went to great efforts throughout 2014 to promote membership in the proposed US\$100 billion AIIB. In October that year, a formal agreement to establish the AIIB was signed by 21 countries. Soon after, China also announced the establishment of its US\$40 billion Silk Road Fund. Various factors have motivated the creation of these new institutions and funds, several of which are discussed below.

Lack of Representation of Emerging Economies at Established IFIs

Since being established, decision making at the World Bank and International Monetary Fund has been dominated by the United States and Europe. The Asian Development Bank, which was formed around 20 years later, has always had a Japanese president. Japan and the United States are the Asian Development Bank’s two top shareholders, with 15.6% and 15.5%, respectively.¹⁵ Relative to both size of economy and population, emerging economies are under-represented at these institutions. Quota reform has been on the agenda of the International Monetary Fund since 2010, but these reforms have been blocked by the United States Congress,¹⁶ and China has become increasingly frustrated with U.S. reluctance to implement such reforms.¹⁷ Similar frustrations have also been raised by other nations.¹⁸

“The world has changed. The balance of economic influence has changed and institutions have not caught up.”

**Singaporean Prime Minister,
Lee Hsien Loong (2015)**

Despite being the world’s second-largest economy and accounting for around 20% of the world’s population, China only has a 4.7% voting share at the World Bank’s International Bank for Reconstruction and Development, compared to 16.7% held by the United States.¹⁹ China holds a 5.5% share of votes at the Asian Development Bank, compared to 12.7% held by the United States and 12.8% by Japan.²⁰ As discussed below, the establishment of the AIIB has created an

¹⁵ As of December 2015: ADB (2015), *Investor Relations: Shareholders*, ADB website.

<http://www.adb.org/site/investors/credit-fundamentals/shareholders> (accessed May 2016).

¹⁶ Harding, R. (2014, 12 December), *Christine Lagarde warns US over IMF reform failings*, Financial Times. <http://www.ft.com/intl/cms/s/0/9026530c-821d-11e4-a9bb-00144feabdc0.html> (accessed May 2016).

¹⁷ Xinhua (2014, 18 April), *China’s Zhou says IMF members frustrated with quota reform delay*, Xinhuanet. http://news.xinhuanet.com/english/2015-04/18/c_134160977.htm (accessed May 2016).

¹⁸ See for example: Channel NewsAsia (2015, 22 April), *AIIB a step in the right direction: PM Lee*, CAN. <http://www.channelnewsasia.com/news/asiapacific/aiibastepintheright/1801712.html> (accessed May 2016).

¹⁹ As of May 2016: <http://siteresources.worldbank.org/BODINT/Resources/278027-1215524804501/IBRDCountryVotingTable.pdf> (accessed May 2016).

²⁰ As of December 2015: <http://www.adb.org/sites/default/files/institutional-document/182852/oi-appendix1.pdf> (accessed May 2016).

institution in which Asian members control the majority of voting shares, with China holding by far the largest share.

Frustrations Regarding Efficiency of Existing International Financial Institutions

The established international financial institutions have come under criticism for being out-dated and in need of reform. The resident board of the World Bank is expensive, costing around US\$70 million per year, and the bank's complex management structure can be cumbersome. This delays investment decisions, which is a major criticism of some World Bank clients. Some borrowers have also pushed back against what they see as burdensome environmental and social policies.²¹ Reluctance to fund sensitive projects such as large-scale hydropower and coal has also frustrated some developing country borrowers that seek financing for such projects.

The AIIB has tapped into these frustrations, and as discussed in more detail below, the bank claims that it will be a "lean" institution with minimal bureaucracy. It will have a non-resident board that meets periodically by video conference, have a much smaller staff than institutions such as the World Bank, and will likely reach decisions on loans more quickly. The AIIB's Environmental and Social Framework represents a watered-down version of the safeguard policies of established international financial institutions, requiring less from the bank and borrowers in terms of due diligence and mitigation of adverse social and environmental impacts.

Global Demand for Infrastructure Finance

According to the Asian Development Bank, Asia requires US\$8 trillion in infrastructure investment between 2010 and 2020,²² and the ASEAN region alone requires US\$60 billion in investment per year in road, rail, power, water, and other critical infrastructure.²³ In 2014, the World Bank provided approximately US\$24 billion to infrastructure *globally*,²⁴ whereas the Asian Development Bank provides some US\$13 billion annually to infrastructure projects in the region.²⁵ Given the limited funding capacity of existing international financial institutions, it is unsurprising that Chinese-led finance initiatives and institutions have been greeted so enthusiastically by the governments of many developing countries.

²¹ Dollar, D. (2015, 6 May), *What the AIIB can learn from World Bank shortcomings*, East Asia Forum. <http://www.eastasiaforum.org/2015/05/06/what-the-aiib-can-learn-from-world-bank-shortcomings/> (accessed May 2016).

²² Asian Development Bank (2012), *Infrastructure for supporting inclusive growth and poverty reduction in Asia*, Mandaluyong City, Philippines: ADB, p.iii.

²³ ADB (no date), *ASEAN Infrastructure Fund*. <http://www.adb.org/site/aif/main> (accessed May 2016).

²⁴ World Bank (2014, 18 July), *World Bank Group's Infrastructure Spending Increases to US\$24 Billion*. <http://www.worldbank.org/en/news/press-release/2014/07/18/world-bank-group-infrastructure-spending-increases-to-24-billion> (accessed May 2016).

²⁵ Solovyov, D. (2015, 2 May), *ADB head will be "very happy" to work with China's Asia infrastructure bank*, Reuters. <http://www.reuters.com/article/2014/05/02/kazakhstan-ADB-banking-idUSL6N0NO1ZG20140502> (accessed May 2016).

China's Increasing Importance as Global Developer, Investor and Financier

Since the adoption of its Going Out strategy in the early 2000s, the Chinese government has provided strong support for outbound investment, and Chinese companies and financiers have become major investors around the world. Through the Going Out strategy, Chinese companies have been encouraged to invest overseas in various sectors, including agriculture, natural resources, infrastructure and construction projects, and to promote trade and export of Chinese products, services and technology. The government facilitates this through the provision of financing, guarantees, foreign exchange and tax incentives.²⁶ After regulations were relaxed in 2004, China's outbound investment skyrocketed and continues to climb.

Chinese Outbound Investment, 1985 - 2014

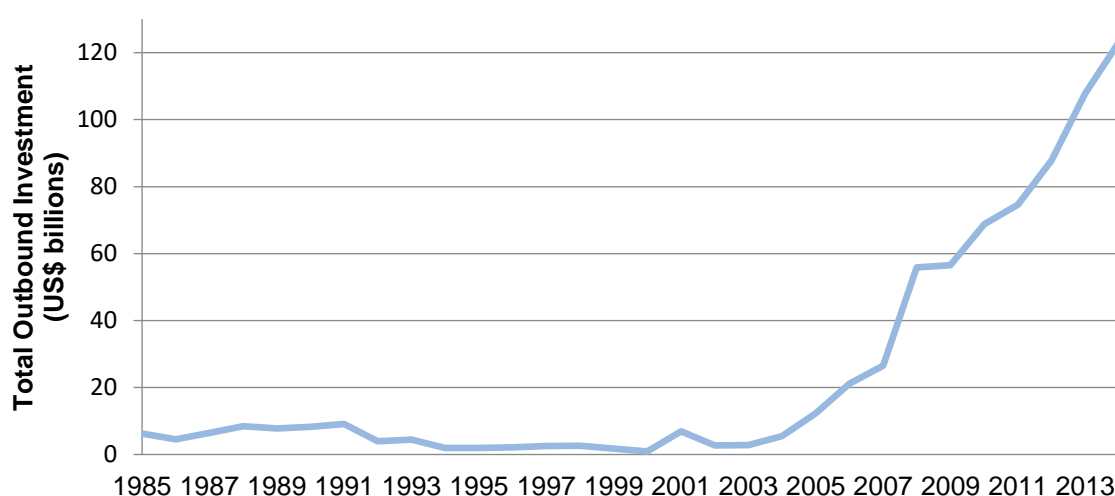

Source: UNCTAD (2015), Ministry of Commerce, China (2015)

There are various motivations behind China's promotion of the Going Out strategy, including the acquisition of natural resources, gaining access to global markets for Chinese goods and services, acquiring technology, and developing industrial capacity and expertise.²⁷ Over the past decade, Chinese firms have developed extensive experience in overseas project development, contracting and financing. Domestically, China's economic growth has been fuelled by massive infrastructure investment, and Chinese firms and financial institutions seek to utilize their experiences and expand their business in other countries.

A number of the developments discussed in this paper, including equity investments by the Silk Road Fund and the China-ASEAN Investment Cooperation Fund, will directly benefit Chinese firms' overseas operations and expansion, as well as supporting acquisition of resources and developing regional interconnectivity.

²⁶ Grimsditch, M. & Yu, Y. (2015), *Development Finance in the BRICS Countries: A Review from China*, New Delhi: Heinrich Böll Foundation.
https://za.boell.org/sites/default/files/development_finance_in_brics_countries.pdf (accessed May 2016).

²⁷ *Ibid.*

As a multilateral institution, the AIIB will not explicitly favour Chinese companies. Under the bank's charter (discussed more later), companies from any country may bid on AIIB contracts, even if their country is not an AIIB member.²⁸ The bank has also adopted a procurement policy that sets out requirements for an "international open competitive tender process."²⁹ However, Chinese companies may have a strong advantage due to their extensive experience in domestic and global infrastructure projects and their ability to provide highly competitive prices for contracting work.

China has stressed that the AIIB is a multilateral institution, not a Chinese bank. Likewise, it has stressed that the One Belt One Road initiative is not a tool of geopolitics, but rather a mutually beneficial roadmap for increasing regional connectivity and economic development. However, there is little doubt that China also seeks to continue to assert itself as a major power both regionally and globally, especially with regards to economic affairs, and these new initiatives will play an important role in achieving this goal.

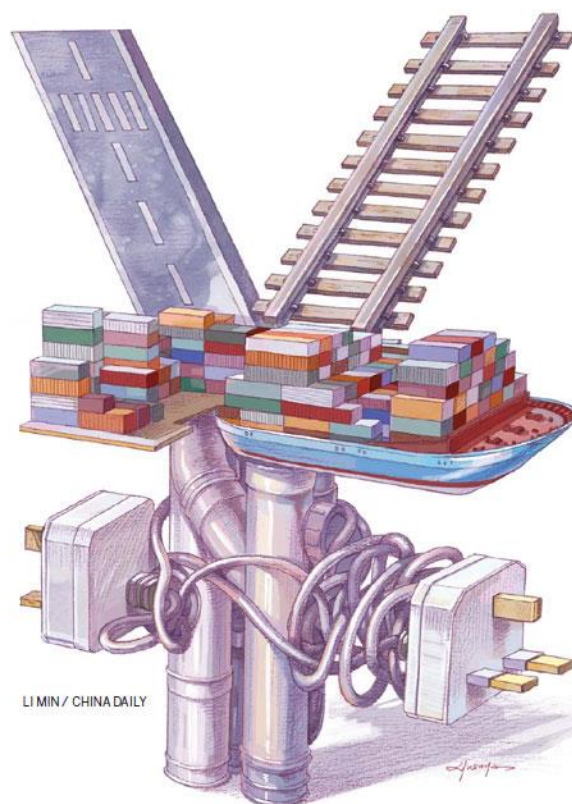

Illustration from China Daily, depicting Chinese finance in infrastructure projects
© Li Men / China Daily, February 2012

China's Foreign Currency Reserves and Internationalization of the Yuan

China's foreign exchange reserves reached almost US\$4 trillion in 2014, around two thirds of which was in U.S. dollars.³⁰ This has since dropped, but remains in excess of US\$3 trillion. The establishment of the AIIB, New Development Bank, and various other investment funds all create opportunities for China to put these extensive reserves to use.

Although the AIIB plans to operate only in U.S. dollars initially, the other financial institutions covered in this paper are likely to increase lending in Chinese renminbi (or yuan). For several years, China has been seeking ways to reduce its financial reliance on the U.S. dollar and increase the global use of the Chinese yuan. As of

²⁸ AIIB (2015), *Articles of Agreement*, article 13.8.

²⁹ AIIB (2016), *Procurement Policy*. <http://www.aiib.org/uploadfile/2016/0226/20160226052146876.pdf> (accessed May 2016).

³⁰ Noble, J. (2014, 15 April), *China's Foreign Exchange Reserves Near Record \$4tn*, Financial Times. <http://www.ft.com/intl/cms/s/0/4768bd3c-c461-11e3-8dd4-00144feabdc0.html> (accessed May 2016).

October 2014, over 22% of China's trade was settled in renminbi, up from almost zero five years before.³¹

Slowdown of the Chinese Economy and Domestic Overcapacity

Another major driver of China's renewed emphasis on outbound investment is its domestic economic slowdown. For years the Chinese economy achieved and maintained its phenomenal growth through massive infrastructure spending, but the country now faces a cooling economy and lower demand for infrastructure construction and materials.³² The Chinese government has labelled the current situation the "new normal" and plans to move away from high-speed growth fuelled by construction and exports towards slower and cleaner growth based on domestic consumption.³³

Although China's economic slowdown has resulted in falling demand for industrial goods and construction materials, production has continued. This has led to a situation where overcapacity in industries such as steel, aluminium, glass and cement have reached unsustainable levels.³⁴ As China comes to terms with reduced economic growth, it is taking steps to address this issue. In addition to closing loss-making factories, the Chinese government is actively encouraging companies to export excess capacity overseas.³⁵

China's highest administrative body, the State Council, has identified "industrial cooperation" with other countries as a top priority, and in 2015 issued guidelines to domestic companies to expand overseas investment, contracting and cooperation in railways, energy, telecommunications, construction and machinery. This strategy is framed as being mutually beneficial, with Chinese companies able to upgrade, improve their ability to operate internationally and offload excess capacity, while also generating employment and economic development in host countries.³⁶ Initiatives such as the One Belt One Road, along with financing from China's policy banks and numerous state-backed investment funds, provide the strong state support and financing required to support China's overseas industrial cooperation.

³¹ Kyngge, J. & Noble, J. (2014, 9 December), *China: Turning away from the dollar*, Financial Times. <http://www.ft.com/cms/s/0/4ee673367edf11e4b83e00144feabdc0.html> (accessed May 2016).

³² Wildau, G. & Mitchell, T. (2016, 19 January), *China annual GDP growth of 6.9% lowest since 1990*, Financial Times. <http://www.ft.com/intl/cms/s/2/e6b04734-bdbb-11e5-a8c6-deeeb63d6d4b.html> (accessed May 2016).

³³ Xinhua (2016, 24 March), *'New normal' offers growth opportunities*, china.org.cn. http://www.china.org.cn/business/2016-03/24/content_38101820.htm (accessed May 2016).

³⁴ He, Y. (2014, 7 January), *China's overcapacity crisis can spur growth through overseas expansion*, South China Morning Post. <http://www.scmp.com/comment/insight-opinion/article/1399681/chinas-overcapacity-crisis-can-spur-growth-through-overseas> (accessed May 2016).

³⁵ Goh, B. & Qing, K.G (2015, 6 September), *China's 'One Belt, One Road' looks to take construction binge offshore*, Reuters. <http://uk.reuters.com/article/2015/09/06/uk-china-economy-silkroad-idUJKKCN0R60X820150906> (accessed May 2015).

³⁶ Xinhua (2015, 7 May), *China hones global competence via industrial prowess*, China Daily Europe. http://europe.chinadaily.com.cn/business/2015-05/07/content_20649665.htm (accessed May 2016); Xinhua (2014, 24 December), *China stresses finance for companies "going global"*, Xinhuanet. http://news.xinhuanet.com/english/china/201412/24/c_133876895.htm (accessed May 2015).

A confluence of the factors outlined above – from frustration with established international financial institutions to a slowing of China’s domestic economy – have encouraged the expansion and evolution of Chinese overseas infrastructure investment in recent years. The remainder of this paper describes some of the main vehicles for Chinese outbound investment, with a focus on several new institutions and initiatives that have been launched in recent years, which have the potential to fundamentally alter the infrastructure finance landscape.



*China Eximbank financed Kostalec B2 coal-fired plant, Serbia
(Photo by CEE Bankwatch Network)*

The Asian Infrastructure Investment Bank

The establishment of the AIIB represents the biggest shake-up of global multilateral finance for decades. China announced plans to establish the bank in October 2013, and one year later 21 Asian countries signed a memorandum of understanding agreeing to join.³⁷ By April 2015, 57 countries had signed on as prospective founding members. The AIIB's initial authorized capital is US\$100 billion, although this may increase in the future.³⁸ The largest stake in the bank is held by China, which has by far the largest share of the voting rights within the institution.



The AIIB's website describes the institution as a “multilateral development bank conceived for the 21st century,” and states:

Its modus operandi will be lean, clean and green: lean, with a small efficient management team and highly skilled staff; clean, an ethical organization with zero tolerance for corruption; and green, an institution built on respect for the environment. The AIIB will put in place strong policies on governance, accountability, financial, procurement and environmental and social frameworks.³⁹

Headquartered in Beijing, the bank focuses on financing infrastructure and “other productive sectors” in Asia, which will include energy and power, transportation and telecommunications, rural infrastructure and agriculture development, water supply and sanitation, environmental protection, urban development, and logistics, among others.⁴⁰ The bank's first projects were announced in April-May 2016, and included energy, transport and urban development projects in Pakistan, Tajikistan, Bangladesh and Indonesia. The bank expects to announce more projects later in 2016.⁴¹

³⁷ Bangladesh, Brunei, Cambodia, China, India, Kazakhstan, Kuwait, Laos, Malaysia, Mongolia, Myanmar, Nepal, Oman, Pakistan, the Philippines, Qatar, Singapore, Sri Lanka, Thailand, Uzbekistan and Vietnam.

³⁸ AIIB, *Articles of Agreement*, article 4.

³⁹ AIIB (no date), *About Us*. <http://www.aiib.org/html/aboutus/introduction/aiib/?show=0> (accessed May 2016).

⁴⁰ *Ibid.*

⁴¹ Jin, L. (2016, 25 June), *President's Report to the Board of Governors: 2016 Annual Meeting of the Board of Governors Asian Infrastructure Investment Bank*. http://euweb.aiib.org/html/2016/NEWS_0625/122.html (accessed June 2016).

AIIB Time Line of Events: October 2013 – May 2016

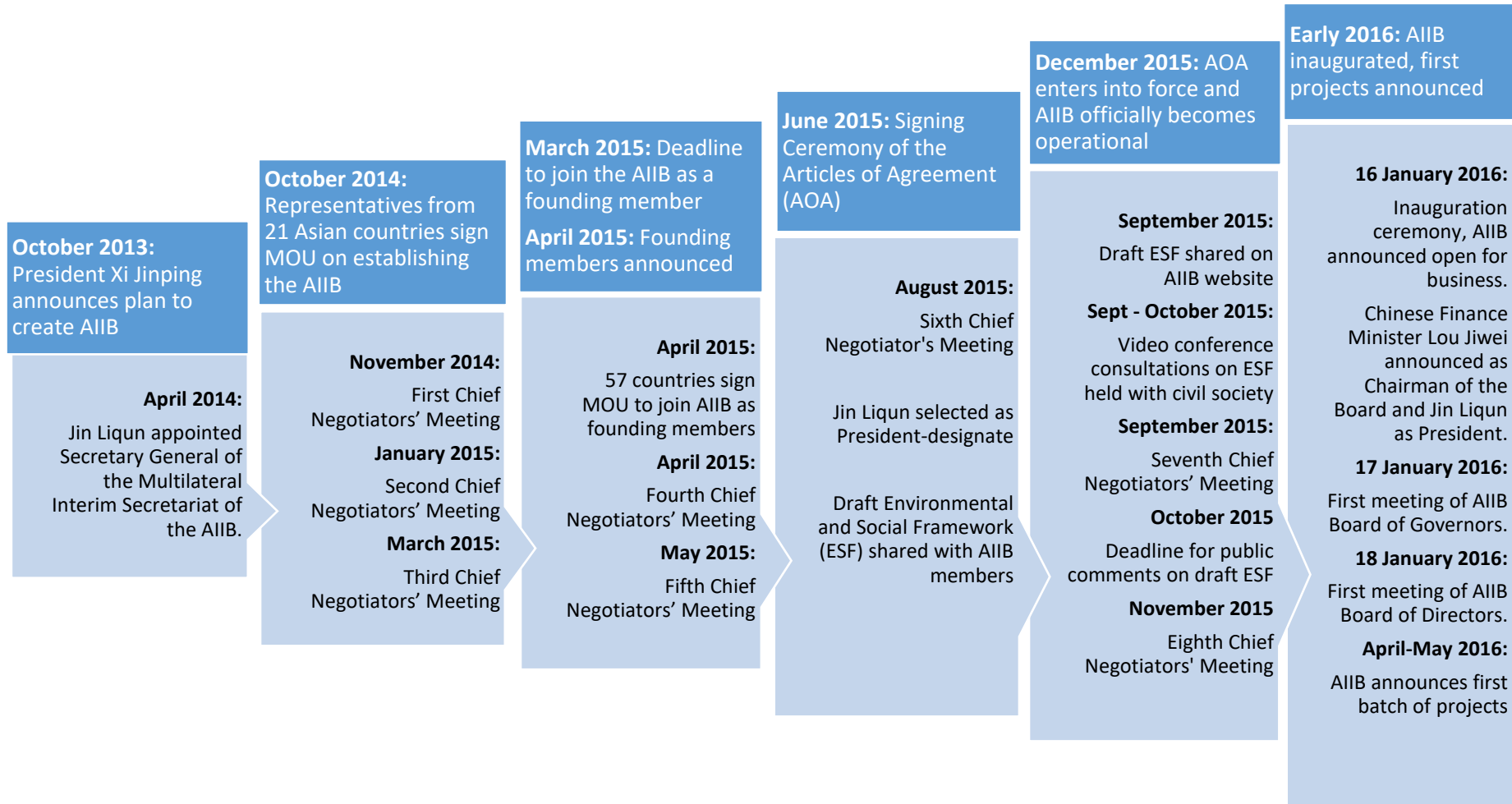

AIIB Membership

Fifty-seven nations signed up as founding members of the AIIB. Other nations can still join the bank, but they will not have the status of founder members, which are entitled to additional votes. Membership is broken down into *regional* and *non-regional* members. Although new members can still join the bank and existing members can increase their shareholding, the total shareholding of regional members may not drop below 75%.⁴² According to the AIIB president, as of June 2016, a further 30 countries were on the waiting list to join.⁴³ A deadline for new applicants has been set as September 30, 2016, and the bank expects to admit new members from early 2017.⁴⁴

AIIB Founding Members⁴⁵

East Asia	Southeast Asia	Central Asia	South Asia	West Asia
China Mongolia South Korea	Brunei Cambodia Indonesia Laos Malaysia Myanmar Philippines Singapore Thailand Vietnam	Kazakhstan Kyrgyzstan Tajikistan Uzbekistan	Bangladesh India Iran Maldives Nepal Pakistan Sri Lanka	Azerbaijan Georgia Israel Jordan Kuwait* Oman Qatar Russia Saudi Arabia Turkey U.A.E.
Oceania	Americas	Africa	Europe	
Australia New Zealand	Brazil	Egypt South Africa	North Denmark Finland Iceland Norway Sweden United Kingdom	South Italy Malta Portugal Spain
			East Poland	West Austria France Germany Luxembourg Netherlands Switzerland

■ Regional members ■ Non-regional members

⁴² AIIB (2015), *Articles of Agreement*, article 5.3.

⁴³ Li, X. (2016, 31 May), *AIIB will have 100 countries as members by year-end: Jin Liqun*, China Daily. http://europe.chinadaily.com.cn/business/2016-05/31/content_25555463.htm (accessed May 2016).

⁴⁴ Jin, L. (2016, 25 June), *President's Opening Statement: 2016 Annual Meeting of the Board of Governors Asian Infrastructure Investment Bank*.

http://euweb.aiib.org/html/2016/NEWS_0625/121.html (accessed June 2016).

⁴⁵ AIIB (2015), *Articles of Agreement*, Schedule A.

All ten ASEAN countries are founding members of the AIIB. Several leaders and senior officials from these countries have expressed their enthusiasm about joining the bank and have made numerous public statements about the potential for the bank to support development in their respective countries. The first batch of projects announced by the AIIB includes one project in the ASEAN region: a slum upgrade project in Indonesia. As the bank's portfolio grows, it is highly likely that it will seek to expand further in Southeast Asia. In May 2016, President Jin was quoted in the media as saying he plans to visit Myanmar later in the year.⁴⁶

Two notable nations that did not join the AIIB are the United States and Japan. Various media reports suggested that while membership of the AIIB was taking shape in 2014 and 2015, the United States government was privately lobbying its allies and encouraging them to decline the invitation to join.⁴⁷ However, the decision of the United Kingdom to join in March 2015 opened the floodgates, and the number of prospective founding members increased dramatically in a short space of time running up to the April deadline.

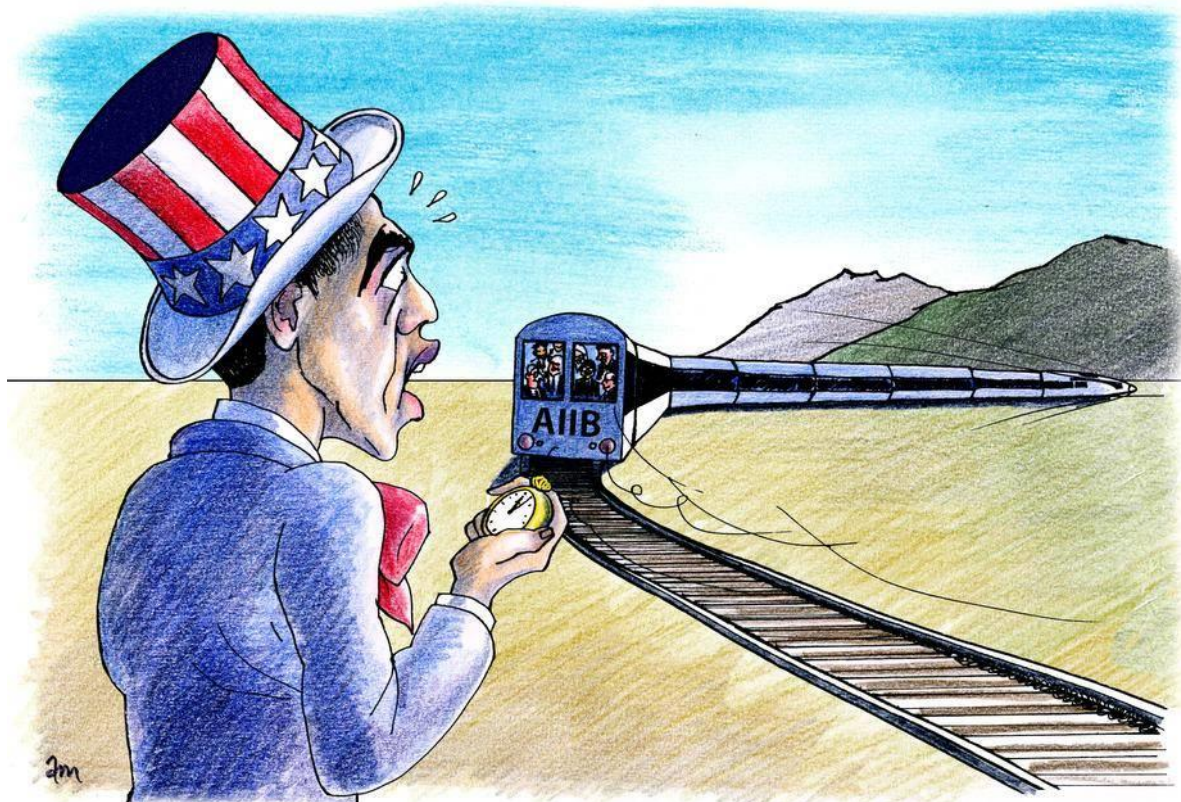

*Illustration by Anne-Marie Steen Petersen
Politiken, March 2015⁴⁸*

⁴⁶ Gilmore, S. (2016, 4 May), *China-led development bank to visit Myanmar*, Myanmar Times. <http://www.mmmtimes.com/index.php/business/20105chinaledinfrabanktovisitmyanmar.html> (accessed May 2016).

⁴⁷ See for example: Funabashi, Y. (2014, 9 December), *A futile boycott of China's bank will not push Xi out of his back yard*, Financial Times. <http://www.ft.com/cms/s/0/afd398426c1811e4b93900144feabdc0.html> (accessed May 2016).

⁴⁸ Anne -Marie Steen Petersen (2015, 23 March), *Express to China*, Politiken. <http://politiken.dk/debat/dagenstegning/ECE2599342/express-to-china/> (accessed May 2016).

Sectoral Focus and Approach of the AIIB

As its name suggests, the focus of the AIIB is on infrastructure investment. The stated purpose of the bank is twofold:

1. To foster sustainable economic development, create wealth and improve infrastructure connectivity in Asia by investing in infrastructure and other productive sectors; and
2. Promote regional cooperation and partnership in addressing development challenges by working in close collaboration with other multilateral and bilateral development institutions.⁴⁹

Statements from the AIIB president suggest that the bank will take a broad view of the term “infrastructure.” In addition to supporting projects such as transport, energy and telecommunications, the bank may also invest in social infrastructure such as the health sector and environmental protection.⁵⁰ The bank is empowered to use a range of methods to disperse its financing, including:

- making, co-financing or participating in direct loans;
- investing funds in the equity capital of an institution or enterprise (i.e. buying shares);
- guaranteeing loans for economic development (i.e. guaranteeing against credit risks in order to encourage investment); and
- providing technical assistance.⁵¹

The Articles of Agreement, which entered into force on December 25, 2015, make clear that the AIIB will seek to mobilize both public and private capital in order to achieve its goals.⁵² President Jin has told the media that the AIIB will combine the features of both public and private institutions in its operation, and will actively promote engagement with the private sector.⁵³

The bank announced its first batch of projects in April-May 2016, followed by two more in July. This included four projects co-financed with other multilateral development banks and two stand-alone projects.⁵⁴ During its first year of operation the bank’s lending target was in the range of US\$500 to US\$1.2 billion.⁵⁵ The AIIB has developed a project pipeline that includes both stand-alone projects and projects for co-financing

⁴⁹ AIIB (2015), *Articles of Agreement*, article 1.

⁵⁰ Hou, L. (2015, 20 September), *AIIB Vows to Engage Private Sector in Asia's Infrastructure Investment*, CRI English. <http://english.cri.cn/12394/2015/09/20/2202s896811.htm> (accessed May 2016).

⁵¹ AIIB (2015), *Articles of Agreement*, article 11.

⁵² AIIB (2015), *Articles of Agreement*, article 2.

⁵³ Xinhua (2015, 21 September), *AIIB vows to engage private sector across world in Asia's infrastructure investment*, China Daily. http://www.chinadaily.com.cn/business/2015-09/21/content_21937599.htm (accessed May 2016).

⁵⁴ AIIB (2015), *Projects*. <http://www.aiib.org/html/PROJECTS/> (accessed May 2016).

⁵⁵ Jin, L. (2016, 25 June), *President's Report to the Board of Governors: 2016 Annual Meeting of the Board of Governors Asian Infrastructure Investment Bank*. http://euweb.aiib.org/html/2016/NEWS_0625/122.html (accessed June 2016).

with other institutions.⁵⁶ Once up and running, the bank aims to be lending US\$10-15 billion a year by 2020.⁵⁷

AIIB Projects Announced Up to July 2016

Country	Project Type	Value	Notes
Pakistan	Highway construction	US\$273m	Co-financed with Asian Development Bank and the UK Department for International Development (DfID).
Tajikistan	Road rehabilitation	US\$106m	Co-financed with European Bank for Reconstruction and Development.
Bangladesh	Power transmission	US\$262m	Implemented by Bangladesh Rural Electrification Board and Dhaka Electric Supply Company.
Indonesia	National Slum Upgrading Project	US\$216.5m	Co-financed with World Bank.
India	Transmission System Strengthening Project*	US\$150m	Standalone project, implemented by Indian state-owned Power Grid Corp.
Pakistan	Tarbela 5 Hydropower Extension Project*	US\$300m	Co-financed with World Bank.

** Indicates project still awaiting board approval at time of writing.*

At the bank's first annual meeting in June 2016, it announced the establishment of a Project Preparation Special Fund. This was supported by a US\$50 million grant from China. This fund will be used to help members to prepare "sound" project proposals, and will provide grants to low and middle income country members for activities such as environmental, social, legal, procurement and technical assessments, and advisory services.⁵⁸

Statements from the AIIB indicate that the bank's lending will not be conditional on economic reforms in borrowing countries – a controversial aspect of other international financial institution lending. In President Jin's opinion, the role of borrower governments is central to a project's success, and the bank should not play an overbearing role:

⁵⁶ Zheng, Y. (2016, 18 January), *AIIB chief vows to run clean, lean, green institution*, China Daily Online. http://www.chinadaily.com.cn/business/2016-01/18/content_23124210.htm (accessed May 2016).

⁵⁷ Zheng, X. (2015, 2 December), *AIIB to lend up to \$15b every year, says top official*, China Daily. http://europe.chinadaily.com.cn/business/2015-12/02/content_22598644.htm (accessed May 2016).

⁵⁸ AIIB (2016, 25 June), *AIIB's Board of Directors establish a Project Preparation Special Fund: China provides initial \$50 million start-up contribution*. http://euweb.aiib.org/html/2016/NEWS_0625/124.html (accessed June 2016).

If we can encourage the project sponsors and local governments to take more responsibility, you can help them develop their institutional capability, instead of being a nanny, to tell them to do this, to do that, you actually deprive them of the initiative to prepare things on their own.⁵⁹

President Jin has stated that regulatory constraints and red tape would “adversely affect” project preparation,⁶⁰ and as stated earlier, the AIIB secretariat has been promoting the bank as a “lean” institution, with streamlined management and reduced bureaucracy.

Shareholding and Voting Powers

China holds roughly 30% of the bank’s shares and over 27% of the voting share. India and Russia are the second- and third-largest shareholders, respectively. Under the Articles of Agreement, certain key decisions require a supermajority of two-thirds of votes of all governors, representing no less than 75% of total shares. As China holds over 27% of votes, it has the ability to exercise a veto over certain decisions. During a press briefing, Deputy Finance Minister Shi Yaobin stated that China will not seek to maintain this veto power, and as new members join the bank in the future China’s share of votes will be diluted.⁶¹

Top 10 Shareholders in the AIIB (as of February 2017)

Member	Capital Subscription (US\$ billion)	Voting Share
China	29.78	27.85%
India	8.37	8.03%
Russia	6.54	6.33%
Germany	4.48	4.44%
South Korea	3.74	3.75%
Australia	3.69	3.70%
France	3.38	3.41%
Indonesia	3.36	3.40%
Brazil	3.18	3.00%*
United Kingdom	3.05	3.11%

Source: AIIB (2017) *Estimated, Brazil has yet to complete membership process

As can be seen above, China’s voting share at the AIIB is much larger than any other member, and bigger than the combined share of India, Russia, Germany, South Korea and Australia, the next five biggest shareholders.

⁵⁹ Xinhua (2015, 21 September), *AIIB vows to engage private sector across world in Asia’s infrastructure investment*, China Daily. http://www.chinadaily.com.cn/business/2015-09/21/content_21937599.htm (accessed May 2016).

⁶⁰ Xinhua (2015, 21 September), *AIIB vows to engage private sector across world in Asia’s infrastructure investment*, China Daily. http://www.chinadaily.com.cn/business/2015-09/21/content_21937599.htm (accessed May 2016).

⁶¹ Zheng, Y. (2015, 30 June), *Lender to boost regional ties*, China Daily. http://usa.chinadaily.com.cn/epaper/2015-06/30/content_21143723.htm (accessed May 2016).

Structure and Management of the AIIB

Under the Articles of Agreement, the AIIB has a three-tiered management structure: Board of Governors, Board of Directors and a President.⁶² The info-graphic below provides a visual representation of the bank's structure and shareholding.

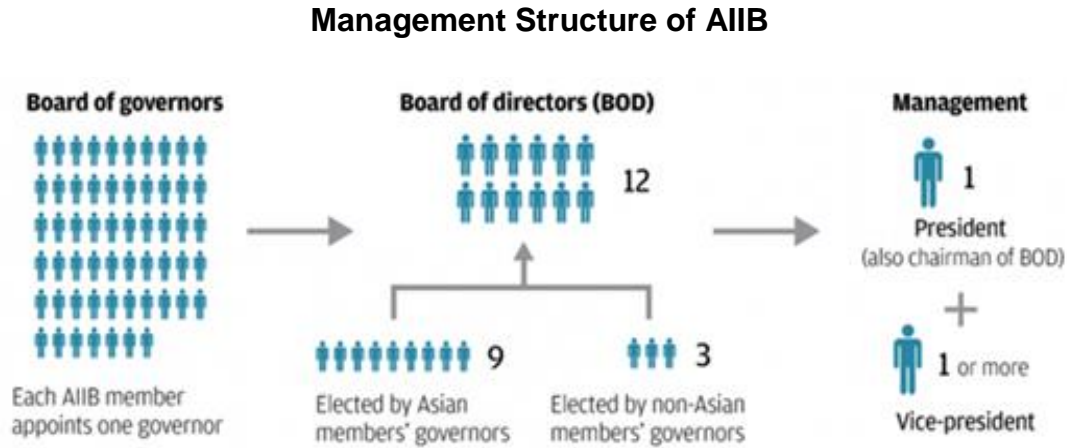

Source: South China Morning Post (2015)

Board of Governors: Every bank member is represented by one governor on the Board of Governors.⁶³ All of the bank's powers are vested in the Board of Governors, although it may delegate powers to the Board of Directors.⁶⁴ Chinese Finance Minister Lou Jiwei is the first chairman of the Board of Governors.

The Board of Directors: This body is composed of 12 members (nine regional and three non-regional).⁶⁵ The Board of Directors is responsible for direction of the general operations of the bank. This includes decisions on major operational and financial policies. The Board of Directors is also responsible for supervision and management of the bank's operations, and the AIIB's oversight mechanism reports to the Board of Directors. In 2016, the bank's directors were appointed, with members assembled into voting blocs.

The President: The AIIB president is elected by a vote of the Board of Governors and must be a national from a regional member.⁶⁶ The current president is Chinese national Jin Liqun. President Jin is a former vice-finance minister and has extensive experience working in both domestic and international financial institutions, including the Asian Development Bank, China Investment Corporation, and China International Capital Corporation.⁶⁷ The AIIB has appointed five vice-presidents, who come from the United Kingdom, South Korea, India, Germany and Indonesia.⁶⁸

⁶² AIIB (2015), *Articles of Agreement*, article 21.

⁶³ AIIB (2015), *Articles of Agreement*, article 22.

⁶⁴ AIIB (2015), *Articles of Agreement*, article 23.

⁶⁵ AIIB (2015), *Articles of Agreement*, article 25.

⁶⁶ AIIB, *Articles of Agreement*, article 29.

⁶⁷ Santos, L.A. & Nito, O. (2014, 15 September), *Jin Liqun: China's helmsman to establish AIIB*, Devex. <https://www.devex.com/news/jin-liqun-china-s-helmsman-to-establish-aiib-84327> (accessed May 2016).

⁶⁸ AIIB (2016, 5 February), *Asian Infrastructure Investment Bank appoints 5 Vice-Presidents*. http://www.aiib.org/html/2016/NEWS_0205/91.html (accessed May 2016).

Directors and Voting Blocs at the AIIB (as of February 2017)⁶⁹

Directors	Casting Votes For	
Australia	Australia New Zealand	Singapore Vietnam
China	China	
Egypt	Brazil Egypt	South Africa
Germany	Austria Finland France Germany Italy	Luxemburg Malta Netherlands Portugal Spain
India	India	
Indonesia	Cambodia Indonesia Laos	Myanmar Sri Lanka
Russia	Iran Kazakhstan	Russia Tajikistan
Saudi Arabia	Kuwait Jordan Oman	Qatar Saudi Arabia United Arab Emirates
South Korea	Israel Mongolia	South Korea Uzbekistan
Turkey	Azerbaijan Brunei Georgia	Kyrgyzstan Pakistan Turkey
Thailand	Bangladesh Malaysia Maldives	Nepal Philippines Thailand
United Kingdom	Denmark Iceland Norway Poland	Sweden Switzerland United Kingdom

⁶⁹ AIIB (2016), *AIIB Directors/Representatives and Alternates*.
http://www.aiib.org/html/aboutus/governance/Board_of_Directors_/BOD_Members/?show=1
 (accessed May 2016).

At the time of writing, all financing requires board approval, but the AIIB is expected to consider delegating approval power later in 2016.⁷⁰ President Jin has stated that in line with the philosophy of “lean” management, the AIIB’s board of directors should take care of overall policies and bank management should bear responsibility for specific projects or programs.⁷¹ According to the president, management will only need to seek approval from the board for the first project of any country; the first project of any sector; and projects over a certain value. Beyond this, approval authority will be delegated by the board to the management, giving management significant power over bank operations.⁷² In contrast, at the World Bank and the Asian Development Bank, all new projects require approval from the board. This provides an important check and balance and plays a crucial role in the system of accountability at these institutions.

AIIB Commitments to Transparency and Anti-Corruption

President Jin has on many occasions stressed the AIIB’s commitment to being “clean” and has personally committed to developing a strong institutional culture based on ethical standards. In 2015, he stated: “I will strive to ensure that the AIIB develops and embodies a corporate ethos that is characterized by transparency, integrity and accountability, and is focused on meaningful and measurable outcomes and results.”⁷³ He has also stated on many occasions that the bank will have a “zero-tolerance attitude” towards corruption.⁷⁴

Under the Articles of Agreement, the bank must establish a policy on information disclosure in order to promote operational transparency.⁷⁵ An interim public information policy was adopted in January 2016. The policy commits the bank to releasing both institutional and operational information unless there is a “compelling reason for confidentiality.”⁷⁶ Importantly, the policy states the bank will publish environmental and social assessment reports, environmental and social management plans and frameworks, resettlement plans and frameworks, indigenous people plans and frameworks, and AIIB reviews of the use of country and corporate systems.⁷⁷ Disclosure of these documents is crucial, but the policy lacks clarity on the timing of this disclosure and is also silent on whether or not information will be published on pipeline projects.

The Articles of Agreement also require that the Board of Directors establish an oversight mechanism to supervise the management and operation of the bank.⁷⁸ The

⁷⁰ AIIB (2016), *Operational Policy on Financing*, article 3.5.1.

⁷¹ Xinhua (2015, 21 September), *AIIB vows to engage private sector across world in Asia’s infrastructure investment*, China Daily. http://www.chinadaily.com.cn/business/2015-09/21/content_21937599.htm (accessed May 2016).

⁷² Donnan, S. & Sevastopulo, D. (2015, 25 October), *AIIB head vows to be clean, lean and green — and fast*, Financial Times. <http://www.ft.com/cms/s/0/b6f95846-7b0d-11e5-a1fe-567b37f80b64.html> (accessed May 2016).

⁷³ AIIB (2015, 26 August), *Statement by Jin Liqun at a Press Conference in Tbilisi*. http://www.aiib.org/html/2015/NEWS_0826/16.html (accessed May 2016).

⁷⁴ Xinhua (2015, 23 March), *AIIB to have zero-tolerance for corruption: official*, Xinhuanet. http://news.xinhuanet.com/english/2015-03/22/c_134087672.htm (accessed May 2015).

⁷⁵ AIIB (2015), *Articles of Agreement*, article 34.

⁷⁶ AIIB (2016), *Public Information Interim Policy*, article 4.

⁷⁷ AIIB (2016), *Public Information Interim Policy*, article 7.

⁷⁸ AIIB (2015), *Articles of Agreement*, article 26.

AIIB states that this mechanism will be “in line with the principles of transparency, openness, independence and accountability.”⁷⁹ This oversight role will be implemented by the Department of Compliance, Effectiveness & Integrity, which has now been established but is still under development at the time of writing.

Environmental and Social Safeguards

According to the AIIB’s Articles of Agreement: “The Bank shall ensure that each of its operations complies with the Bank’s operational and financial policies, including without limitation, policies addressing environmental and social impacts.”⁸⁰ In February 2016, the Board of Directors approved the Environmental and Social Framework, which sets out the standards and policies that should be implemented in AIIB financed projects. After three years, the framework will be reviewed and updated as required, in order to reflect experiences from its application.⁸¹

The Environmental and Social Framework consists of an introduction and vision, an environmental and social policy with mandatory requirements for each project, and three environmental and social standards providing more detail on project assessment and management, involuntary resettlement, and indigenous people. The framework also contains an exclusion list of activities or items that the AIIB will not knowingly finance.

“The Bank shall ensure that each of its operations complies with the Bank’s operational and financial policies, including without limitation, policies addressing environmental and social impacts.”

AIIB, Articles of Association, article 13

While not part of the binding components of the framework, the vision statement contains some progressive language, stating that the AIIB subscribes to the principle of sustainable development in the identification, preparation and implementation of projects.⁸² The vision statement says that the AIIB “believes that social development and inclusion are critical for sound development,” defining inclusion as “empowering people to participate in, and benefit from, the development process.”⁸³ Notably, it goes on to say:

[The AIIB] also embraces action to remove barriers against vulnerable groups, who are often excluded from the development process, and to ensure that their voices can be heard. In this regard, the Bank seeks, through the Projects it finances, to be supportive of these human rights and to encourage respect for them, in a manner consistent with its Articles of Agreement.⁸⁴

The vision statement also includes encouraging language regarding its commitment to ensuring stakeholder engagement:

⁷⁹ AIIB (no date), *Purpose, Functions and Membership*, <http://www.aiibank.org/html/pagefaq/Key/> (accessed May 2016).

⁸⁰ AIIB (2015), *Articles of Association*, article 13.

⁸¹ AIIB (2016), *Environmental and Social Framework*, para 4.

⁸² AIIB (2016), *Environmental and Social Framework*, para 7.

⁸³ AIIB (2016), *Environmental and Social Framework*, para 8.

⁸⁴ AIIB (2016), *Environmental and Social Framework*, para 8.

The Bank believes that transparency and meaningful consultation is essential for the design and implementation of a Project and works closely with its Clients to achieve this objective. Meaningful consultation is a process that begins early and is ongoing throughout the Project. It is inclusive, accessible, timely and undertaken in an open manner. It conveys adequate information that is understandable and readily accessible to stakeholders in a culturally appropriate manner and in turn, enables the incorporation of stakeholders' views as part of decision-making.⁸⁵

However, despite its progressive vision, the Environmental and Social Framework contains a number of shortcomings and gaps. A draft version was made available in September 2015, and civil society groups were given a brief opportunity to comment. During the public consultation period, numerous civil society groups, including Inclusive Development International, submitted comments to the AIIB raising concerns regarding the draft framework.⁸⁶

The Environmental and Social Framework, as adopted, contains a number of important improvements upon the first draft, addressing some of the concerns raised by Inclusive Development International and other groups, but major weaknesses remain. These include the narrow coverage of the framework, with tailored standards only covering the specific issues of resettlement and indigenous peoples, both of which fall below human rights standards and best practice. For example, the AIIB states that it will not knowingly finance projects that involve or result in forced evictions – a commendable commitment. Under the Framework, evictions can only be carried out in “a manner consistent with basic principles of due process”. However, the definition of forced evictions under the Framework excludes evictions carried out in the exercise of eminent domain or compulsory acquisition under domestic laws.⁸⁷ This is despite the fact that the laws of many countries that are AIIB members do not require that projects causing displacement genuinely promote the general welfare or that the displacement and associated risks are reasonable and proportionate to the public good that will ensue. Therefore, the Framework may not prevent evictions of communities that occur to provide land to private companies for investments that have no legitimate public interest value.

The standard intended to safeguard the rights and interests of indigenous peoples also not only fall below international recognized human rights standards but also establish a benchmark lower than the standards of other international financial institutions. Of most concern, the final version of the standards has removed any reference to a need to secure Free, Prior and Informed Consent (FPIC), which existed in previous drafts, and replaced it instead with the ill-defined concept of Free, Prior and Informed *Consultation* (FPICon). This is a less rigorous standard and provides indigenous communities a lesser entitlement than the well-accepted standard of FPIC. FPICon as defined by the AIIB requires an expression of “broad community support,” and specifically notes that this “does not require unanimity and may be achieved even when individuals or groups within or among Indigenous Peoples explicitly disagree with support for the project.”⁸⁸ Previous use of the standard of FPICon at the World

⁸⁵ AIIB (2016), *Environmental and Social Framework*, para 13.

⁸⁶ IDI (2015), *Comments on the AIIB Draft Environmental and Social Framework*.

<http://www.inclusivedevelopment.net/wp-content/uploads/2015/10/IDI-Comments-on-AIIB-ESF.pdf>.

⁸⁷ AIIB (2016), *Environmental and Social Framework*, para 72 and footnote 19.

⁸⁸ AIIB (2016), *Environmental and Social Framework - Environmental and Social Standard 3: Indigenous Peoples*.

Bank was plagued by uncertainty and implementation difficulties, rendering it unable to protect good development practice, and the human rights that underpin that.⁸⁹ This was in part because a focus on assessing ‘broad community support’ removes the authority of people to express for themselves, through their own decision making structures, their view of a proposed project.⁹⁰

Both the standards on resettlement and on indigenous people lack detail about essential elements of a resettlement plan and indigenous peoples plan that are necessary to ensure they are effective in preventing harm and providing development opportunities, as called for in the objectives. Other concerns relate to the overarching policy, such as the discretion vested in the bank over whether the standards apply to projects that do not have “significant” adverse impacts, but do have some potential negative impacts (i.e. category B projects).⁹¹ The framework lacks detail with regards to financial intermediary lending, and financial intermediary clients do not need to apply the standards to category B subprojects, unless otherwise decided by the bank.⁹²

The Environmental and Social Framework refers to an oversight mechanism that people can submit complaints to if they believe they have been, or are likely to be, adversely affected by a failure of the bank to implement the framework.⁹³ This mechanism will be under the AIIB’s Department of Compliance, Effectiveness & Integrity. The department will be responsible for monitoring policy compliance, evaluating quality and measuring implementation outcomes and results of the AIIB’s investment portfolio. It will receive both internal and external grievances and will report directly to the Board of Directors.⁹⁴ At the time of writing, the AIIB has appointed the head of this department, but its operational policies are yet to be adopted and it is not yet fully staffed.

Like the complaints mechanisms of other international financial institutions, a strong oversight mechanism is crucial to holding the bank accountable and safeguarding against harms to project-affected people or facilitating redress after the fact. To fulfil this potential, the AIIB mechanism’s mandate, powers and operating procedures will need to meet minimum standards, including the effectiveness criteria on non-judicial grievance mechanisms contained in the UN Guiding Principles on Business and Human Rights.⁹⁵

⁸⁹ *United Nations Declaration on the Rights of Indigenous Peoples* (2007), article 42. See also, Forest Peoples Programme (2016), *Briefing Note on Effective Participant and Free, Prior and Informed Consent*, for an explanation on the operational difference between FPIC and “broad community support”. <http://www.forestpeoples.org/sites/fpp/files/publication/2016/03/fpp-fpic-not-fpicon-final.pdf>.

⁹⁰ As required by *United Nations Declaration on the Rights of Indigenous Peoples* (2007), article 42.

⁹¹ AIIB (2016), *Environmental and Social Framework*, para 13 and 37.

⁹² AIIB (2016), *Environmental and Social Framework*, para 13.

⁹³ AIIB (2016), *Environmental and Social Framework*, para 64.

⁹⁴ AIIB (2016, 14 April), *Mr. Hamid Sharif appointed as Director General of the Compliance, Effectiveness and Integrity Unit*. http://www.aiib.org/html/2016/NEWS_0414/100.html (accessed May 2016).

⁹⁵ For an examination of the application of the effectiveness criteria to a range of the accountability mechanisms, see: C. Daniel et al. (Eds.) (2006), *Glass Half Full? The State of Accountability in Development Finance*, Amsterdam: SOMO. <http://www.inclusivedevelopment.net/idi-and-10-partners-launch-major-new-report-on-accountability-in-development-finance/>.

Public Consultations on the AIIB Environmental and Social Framework

The first draft Environmental and Social Framework was posted on the AIIB website and public consultations were announced on September 7, 2015. The first consultation was held just three days later. Consultations were conducted through online video conferences. This process was initially planned to run for only seven days (including 22 sessions). The process came under considerable criticism from civil society groups and was subsequently extended to October 23, with additional sessions scheduled. It was also possible for civil society groups to submit written comments via email.

The consultation process was problematic for multiple reasons. The draft Environmental and Social Framework was released just a few days before the video conferences began, and the video conferences were conducted only in English, excluding many local civil society groups from the process. The framework draft was also only made available in English. Many Asian civil society groups were unable to review a complex 35-page English-language document and prepare for an English-language consultation in the space of just a few days. This rendered the consultation process inaccessible to many important stakeholders.

Interaction Between AIIB and Other Financial Institutions

China has been eager to emphasize that the AIIB will complement the work of the existing multilateral financial institutions rather than act as a competitor. The AIIB's Articles of Agreement state that the bank will work closely with other international financial institutions and organizations concerned with economic development of the region.⁹⁶ Because the bank is a new institution and still needs to recruit a full staff to run and manage operations, the AIIB has been eager to identify opportunities to co-finance projects with already established institutions. At the time of writing, three of the bank's five approved projects involve co-financing.

In the first half of 2016, the World Bank, Asian Development Bank, European Investment Bank and European Bank for Reconstruction and Development signed agreements with the AIIB to explore opportunities for co-financing. As mentioned earlier, the AIIB has already approved co-financed projects with the Asian Development Bank, UK Department for International Development, World Bank and European Bank for Reconstruction and Development. The leaders of the International Monetary Fund, African Development Bank, Islamic Development Bank and the New Development Bank have also expressed an interest in cooperating. The European Union has also made efforts to develop a relationship with the AIIB, and at the 2015

"If we co-finance, we will study how we do things, but I don't have any intention to lower our standards."

President Nakao, ADB (2015)

⁹⁶ AIIB (2016), *Articles of Agreement*, article 35.

EU-China Summit the E.U. stated that it looked forward to future cooperation with the AIIB.⁹⁷

The implications of these co-financing arrangements are potentially significant. On one hand the addition of the AIIB will increase the pool of available finance, which could help to fill existing shortfalls. The injection of capital from the AIIB will allow the banks to combine resources, which may facilitate taking on larger projects and sharing risks. The AIIB may also be able to fit into existing donor-supported frameworks. For example, in the Mekong region, the Greater Mekong Sub-region framework is already utilized by both multilateral and bilateral donors as a venue through which to collaborate or coordinate activities. With its focus on infrastructure, it is likely that the AIIB will become a key partner in this framework.

Importantly, in cases where AIIB co-finances projects with the World Bank and Asian Development Bank and other international financial institutions, the social and environmental standards or safeguard policies of those institutions are likely to apply. Under the World Bank's proposed new environmental and social framework, where the bank is jointly financing a project with other multinational agencies, a common approach for addressing environmental and social impacts must be agreed upon. The common approach must enable the project to achieve objectives "materially consistent" with the objectives of the World Bank's proposed new standards.⁹⁸ Additionally, Asian Development Bank President Takehiko Nakao has stated: "If we co-finance, we will study how we do things, but I don't have any intention to lower our standards."⁹⁹

"I congratulate Secretary General Jin Liqun and all prospective founding members on the great progress made in establishing the AIIB. More funding for infrastructure will help the poor, and we are pleased to be working with China and others to help the AIIB hit the ground running."

President Kim, World Bank (2015)

"I am very pleased to have this framework of collaboration with a new and strong partner in Asia [...] ADB has been working closely with AIIB throughout its establishment process. We will further strengthen our cooperation in promoting sustainable growth, reducing poverty, and combatting climate change in the region."

President Nakao, ADB (2016)

"I very much welcome the role that the AIIB will play in helping to narrow the huge infrastructure investment gap that emerging economies face. We have already built up close ties with the AIIB and shared our own experiences. I now look forward to strengthening this association and working together on joint projects."

President Suma, EBRD (2016)

⁹⁷ EU-China Summit Joint Statement (2015, 29 June), *The Way Forward After Forty Years of EU-China Cooperation*. <http://www.consilium.europa.eu/en/press/press-releases/2015/06/29-eu-china-statement/> (accessed May 2016).

⁹⁸ World Bank, Environmental and Social Standard 1 (Second Draft for Consultation July 1, 2015), paragraph 8.

⁹⁹ Bermingham, F. (2015, 6 May), *ADB and IFC Commit to AIIB Collaboration*, Global Trade Review. <http://www.gtreview.com/news/asia/adb-and-ifc-commit-to-aiib-collaboration/> (accessed May 2016).

Co-financing with the World Bank or the Asian Development Bank is also likely to mean that if project-affected people are adversely impacted by a project because adequate social safeguards are not in place, they can file a complaint to the respective accountability mechanism of the established institutions. Therefore, co-financing in the early years should mean that stricter environmental and social standards will apply to AIIB-supported projects. This will also allow the AIIB to develop its capacity for addressing environmental and social risks and impacts associated with its projects.

Comparison of World Bank, Asian Development Bank and AIIB

	World Bank		ADB		AIIB	
Created	1945		1966		2015	
Headquarters	Washington		Manila		Beijing	
Members	188		67		57	
Largest shareholder	United States		Japan		China	
Voting shares¹⁰⁰	U.S.	16.7%	Japan	12.8%	China	27.85%
	Japan	7.2%	U.S.	12.7%	India	8.03%
	China	4.9%	China	5.5%	Russia	6.33%
Mission	To end extreme poverty and promote shared prosperity.		To foster economic growth and cooperation in Asia and contribute to economic development of the developing member countries.		To foster sustainable economic development, create wealth and improve infrastructure connectivity in Asia.	

¹⁰⁰ World Bank voting shares refers to the International Bank for Reconstruction and Development.

The One Belt One Road Initiative

A major initiative that has emerged from China in recent years is One Belt One Road.¹⁰¹ This refers to a development strategy announced by President Xi Jinping in 2013 that seeks to increase interconnectivity between China and numerous other countries en route to Europe.¹⁰² One Belt One Road seeks to promote and facilitate development of transport, energy, trade and communications infrastructure, among other things. Since the initiative was announced there has been much speculation about how it will be implemented, what type of projects will be included, how they will be financed and developed, and even which countries are included in the One Belt One Road route. Despite there being overlaps in geographical and sectoral focus, the initiative is distinct from the AIIB.

Rather than being a concrete plan or single finance facility, One Belt One Road sets out an overall vision for China's global investment in the coming years. While it is packaged as a new initiative, it is in fact a continuation of China's on-going push to develop regional connectivity and trade routes, enhance the international presence of Chinese companies, and increase access to global markets. In this sense, it can be seen as the next phase of China's Going Out strategy.

Although One Belt One Road was announced in 2013, the Chinese government did not release any official documents on the initiative until March 2015, and there are still considerable information gaps. This section of the paper looks at what is currently known about this initiative, and how this relates to the ASEAN region.

What is One Belt One Road?

The One Belt One Road initiative consists of two main components: the land-based Silk Road Economic Belt, and the oceanic 21st Century Maritime Silk Road. The Silk Road Economic Belt seeks to link China with Europe through Central and Western Asia. The Maritime Silk Road will connect China to Europe via maritime links passing through Southeast and South Asia and on to Africa. One Belt One Road is not simply about developing these two routes, but rather about developing a network of interconnectivity. The initiative includes multiple additional routes linking to the two main corridors, as illustrated below in a map published by Chinese state media.¹⁰³ The Chinese government has stated that more than 60 countries have expressed an interest in the initiative,¹⁰⁴ but due to the flexible nature of the initiative there is no definitive list of countries or projects it covers.

¹⁰¹ "One Belt One Road" is a literal translation. It is also sometimes called the "Belt and Road" initiative.

¹⁰² For a chronology of OBOR development see: <http://en.xinfinance.com/html/OBAOR/Main%20Step/index.shtml> (accessed May 2016).

¹⁰³ Chan, J. (2015, 15 April), "*Belt and Road*" takes new route, China Daily. http://europe.chinadaily.com.cn/business/2015-04/15/content_20435638.htm (accessed May 2016).

¹⁰⁴ Xinhua (2015, 28 March), *Xi on "Belt and Road": Not China's solo but inspiring chorus*, Xinhuanet. http://news.xinhuanet.com/english/2015-03/28/c_134105208.htm (accessed May 2016).

Routes of the China-proposed Belt and Road Initiative



Source: *China Daily* (2015)

In March 2015, China's National Reform and Development Commission, Ministry of Foreign Affairs and Ministry of Commerce jointly released the *Vision and Actions on Jointly Building Silk Road Economic Belt and 21st-Century Maritime Silk Road* (hereafter referred to as the OBOR Vision). In its introduction, the document frames the initiative in terms of its benefit for all the countries involved:

Accelerating the building of the Belt and Road can help promote the economic prosperity of the countries along the Belt and Road and regional economic cooperation, strengthen exchanges and mutual learning between different civilizations, and promote world peace and development. It is a great undertaking that will benefit people around the world.¹⁰⁵

The language used in the OBOR Vision is notably pro-market, and states that the initiative embraces the trend towards economic globalization and "is designed to uphold the global free trade regime and the open world economy."¹⁰⁶ The document goes on to state that the initiative will "abide by market rules and international norms, give play to the decisive role of the market in resource allocation and the primary role of enterprises, and let the governments perform their due functions."¹⁰⁷

OBOR Priority Economic Corridors

China-Mongolia-Russia
 New Eurasian Land Bridge
 China-Central Asia-West Asia
 China-Pakistan
 Bangladesh-China-India-Myanmar
 China-Indochina Peninsula

¹⁰⁵ National Development and Reform Commission, Ministry of Foreign Affairs & Ministry of Commerce of the People's Republic of China (2015), *Vision and Actions on Jointly Building Silk Road Economic Belt and 21st-Century Maritime Silk Road*.

http://en.ndrc.gov.cn/newsrelease/201503/t20150330_669367.html (accessed May 2016).

¹⁰⁶ *Ibid.*

¹⁰⁷ *Ibid.*

The OBOR Vision states that the initiative will use economic industrial parks as cooperation platforms, and at sea the initiative will focus on building “smooth, secure and efficient” transport routes connecting major sea ports along the One Belt One Road route.¹⁰⁸ Within this framework the vision document refers to six major economic corridors.¹⁰⁹ The route of the six corridors is illustrated in the map below.

Economic Corridors within the One Belt One Road Initiative¹¹⁰

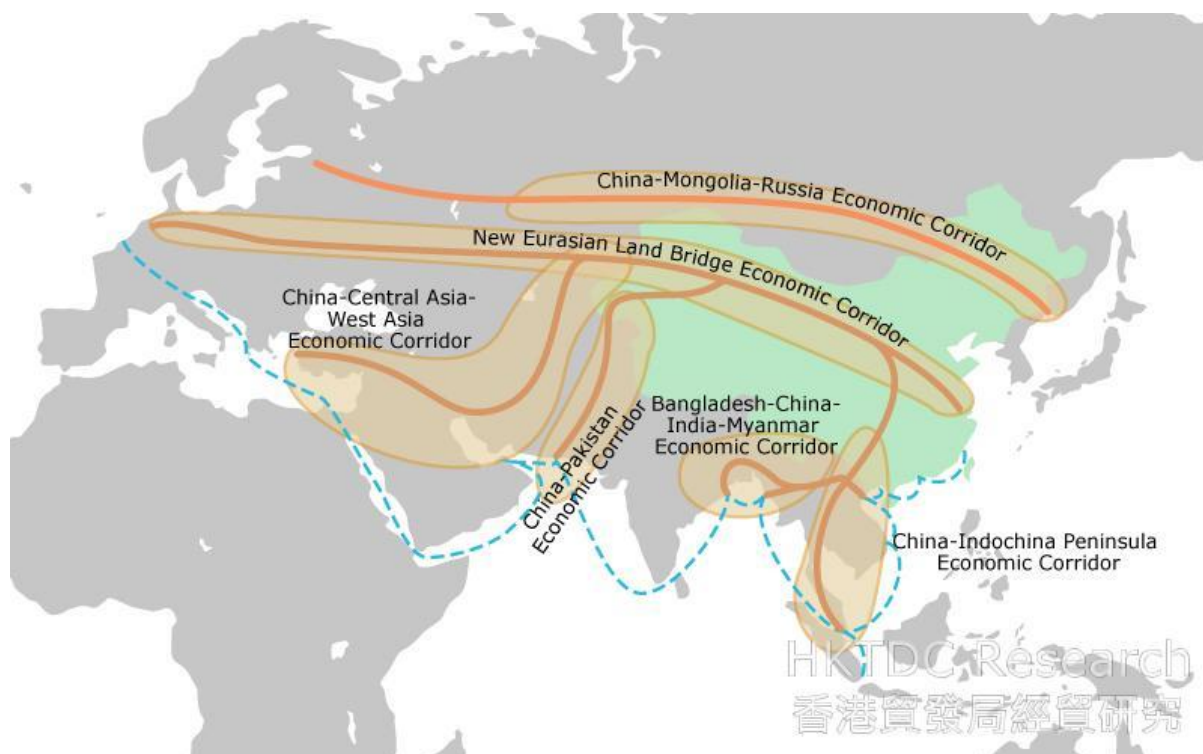

Source: HKTDC Research (2015)

A key goal of One Belt One Road is “policy coordination,” which envisions coordination of economic development strategies and policy support for cooperation and large-scale projects.¹¹¹ “Facilities connectivity” is another priority area of the initiative, and central to its success. This includes improving infrastructure connectivity, construction of international transport corridors, and development of an infrastructure network connecting all sub-regions in Asia, and thereafter Asia, Europe and Africa. The initiative also includes development of energy infrastructure, especially oil and gas pipelines, cross-border power transmission and upgrading of regional power grids.¹¹²

Another major focus of the initiative is the removal of investment and trade barriers and establishing free trade areas. The OBOR Vision highlights investment in multiple

¹⁰⁸ *Ibid.*

¹⁰⁹ *Ibid.*

¹¹⁰ Wong, B. (2015, 16 April), “One Belt, One Road” Initiative: The Implications for Hong Kong, HKTDC Research. <http://economists-pick-research.hktdc.com/business-news/article/Research-Articles/One-Belt-One-Road-Initiative-The-Implications-for-Hong-Kong/rp/en/1/1X000000/1X0A23WV.htm> (accessed May 2016).

¹¹¹ National Development and Reform Commission et al (2015), *Vision and Actions on Jointly Building Silk Road Economic Belt and 21st-Century Maritime Silk Road*.

¹¹² *Ibid.*

areas, including agriculture, forestry, fisheries, environmental protection industries, tourism, and calls for increased cooperation in the exploration and development of coal, oil, gas, hydropower, nuclear, wind and solar power.¹¹³ In order to make the initiative a reality, China will seek to develop new memoranda of understanding, plans and bilateral cooperation projects.¹¹⁴

Motivations for Establishing One Belt One Road

China's One Belt One Road vision emphasizes the mutual benefits of One Belt One Road and the potential for increased cooperation and investment to benefit countries with underdeveloped infrastructure. It seeks to utilize the initiative to further integrate into the global economic system and deepen its domestic policy of 'opening-up', a process that has been on-going since Deng Xiaoping embraced certain market reforms in the 1980s.¹¹⁵ The initiative acts as a roadmap for both facilitating China's integration into the global economy and increasing its influence within these regions. Many of the countries along this route already have close trade and investment links with China, and the initiative will potentially support the deepening of these ties.

If One Belt One Road is successful in both generating new opportunities for investments and in mobilizing new sources of finance, Chinese firms are likely to benefit from contracts to design, develop and operate projects under the initiative. State-owned enterprises in particular have been encouraged by the Chinese government to seek opportunities to invest in One Belt One Road countries, but many private companies have also expressed support for the initiative.¹¹⁶

Increased connectivity may create new markets for Chinese goods to flow to the world, while also increasing China's access to much needed natural resources and energy supplies. In addition to increasing China's influence in global economic affairs, the initiative will increase opportunities for the country to export technology and production capacity in areas that are operating overcapacity domestically, including in the construction, steel and concrete industries. The Chinese government aims to accelerate equipment export, promote industrial cooperation with other countries, and move Chinese production lines to other countries while simultaneously upgrading production within China. Premier Li Keqiang has stated that this process will be focused primarily on countries involved in the One Belt One Road initiative.¹¹⁷ Finally, although China is eager to stress that the initiative is not a tool of geopolitics, there is little doubt that Beijing also sees this initiative as an opportunity to continue to assert itself as a major power in the Asia region, and globally.

¹¹³ *Ibid.*

¹¹⁴ *Ibid.*

¹¹⁵ *Ibid.*

¹¹⁶ Xinhua (2015, 19 June), *Chinese Premier emboldens state firms' int'l industrial cooperation*. China Daily Online. http://www.chinadaily.com.cn/china/2015-06/19/content_21056915.htm (accessed May 2016).

¹¹⁷ Xinhua (2015, 3 April), *China to accelerate int'l industrial cooperation: premier*, Xinhuanet. http://news.xinhuanet.com/english/2015-04/03/c_134123919.htm (accessed May 2016).

Management of One Belt One Road

One Belt One Road is not an institution and is not coordinated by a single entity. However, it is a government-driven initiative, and since March 2015 it has been overseen by the Leading Group for Advancing the Development of One Belt One Road. This group sits under China's top planning agency, the National Development and Reform Commission.¹¹⁸ Its members include senior government officials, and it is headed by Vice Premier Zhang Gaoli, who is also a member of the Communist Party of China's Politburo Standing Committee.¹¹⁹ Little is known about the exact role of this group, but the seniority of its members is evidence of the importance that the government places on this initiative.

China is reportedly working on sector-specific plans for areas including energy, agriculture, environmental protection, education and cultural cooperation under the initiative.¹²⁰ However, the OBOR Vision document states that development of the initiative is a flexible process that will differ from place to place, and China will cooperate with other countries along the route to "work out relevant timetables and roadmaps, and align national development programs and regional cooperation plans."¹²¹

"If I may use a musical metaphor, the [One Belt One Road] initiatives are not China's solo, but a symphony performed by all relevant countries."

**Chinese Foreign Minister,
Wang Yi (2015)**

It is envisioned that the initiative will be implemented through new bilateral cooperation projects, but also through existing multilateral and regional entities, such as ASEAN and the Greater Mekong Sub-region. The large number of potential actors involved therefore means that there is no single body responsible for oversight and management. Given the broad nature of this initiative, many actors are likely to be involved in future One Belt One Road projects, including Chinese state entities responsible for overseeing outbound investment, national and subnational authorities in host nations, regulators, Chinese companies, non-Chinese joint-venture partners, various state and commercial financiers, and so on.

¹¹⁸ Xinhua (2015, 29 March), *China sets up leading team on Belt and Road initiative*, Xinhuanet. http://news.xinhuanet.com/english/2015-03/29/c_134107435.htm (accessed May 2016).

¹¹⁹ Blanchard, B. (2015, 17 April), *China sets up coordinating group for modern Silk Road*, Reuters. <http://www.reuters.com/article/2015/04/17/china-silkroad-idUSL4N0XE3G220150417> (accessed May 2016).

¹²⁰ Xinhua (2015, 20 November), *China works on sector-wise plans on "Belt and Road" initiatives*, Xinhua Finance. <http://en.xinfinance.com/html/Policy/2015/167919.shtml> (accessed May 2016).

¹²¹ National Development and Reform Commission et al (2015), *Vision and Actions on Jointly Building Silk Road Economic Belt and 21st-Century Maritime Silk Road*.

Environmental and Social Safeguards Attached to One Belt One Road

China's Foreign Minister has stated that the One Belt One Road would incorporate "wide consultation" and shared benefits, and that it will ensure transparency and openness.¹²² The OBOR Vision makes several broad commitments to pursuing environmentally friendly projects, for example:

We should promote ecological progress in conducting investment and trade, increase cooperation in conserving eco-environment, protecting biodiversity, and tackling climate change, and join hands to make the Silk Road an environment-friendly one.¹²³

The OBOR Vision also calls on companies operating under the initiative to contribute to local economies, employment and livelihoods, and states that efforts should be made to promote green and low-carbon projects, taking into full account the impact of climate change.¹²⁴

However, due to the broad range of actors involved in implementing projects, no single set of standards or guidelines will apply to environmental and social impacts or other aspects of project design and implementation. Instead, One Belt One Road projects will need to abide by applicable domestic local laws and regulations, as well as the institutional safeguards and policies of the financiers and other actors involved in the project in question. For example, if the AIIB supports a project within the One Belt One Road, its environmental and social framework will apply. Likewise, Chinese policy banks such as the Eximbank should be bound by local regulations and their own internal policies (returned to later).

China is growing increasingly sensitive to the reputation and local perceptions of Chinese companies operating overseas. In some high-profile cases in recent years, popular opposition to major Chinese projects has interfered with their implementation or even led to cancellation. This has most certainly resulted in the Chinese government paying increased attention to how Chinese companies operate overseas. It has created a foundation on which Chinese state institutions have begun to develop increasingly detailed guidelines for outbound investment and finance. However, despite the stated "green" vision of One Belt One Road, the absence of an overarching set of environmental and social standards weakens the accountability of the initiative. Yet, given the importance the Chinese government places in One Belt One Road, and its use as a key platform to promote Chinese investment overseas, the government may be sensitive to reputational risks that harmful projects pose to the initiative as a whole. This potentially opens the door for civil society groups to raise concerns around specific One Belt One Road projects as part of a broader strategy for lobbying China to improve oversight and develop grievance mechanisms for overseas finance and investment.

¹²² Xinhua (2015, 8 March), *China's Belt and Road initiatives not solo, but symphony*, Xinhuanet. http://www.chinadaily.com.cn/business/2015-03/08/content_19750844.htm (accessed May 2016).

¹²³ National Development and Reform Commission et al (2015), *Vision and Actions on Jointly Building Silk Road Economic Belt and 21st-Century Maritime Silk Road*.

¹²⁴ *Ibid*.

One Belt One Road Projects and the ASEAN Region

As can be seen in the map above, ASEAN nations fall within the Bangladesh-China-India-Myanmar Economic Corridor and the China-Indochina Peninsula Economic Corridor. The OBOR Vision stresses the importance of southwest China as a gateway that connects to both the land and oceanic Silk Road routes. The document includes specific reference to linking Yunnan province to its neighbours, Myanmar, Laos and Vietnam, as part of a “pivot of China’s opening-up to South and Southeast Asia.”¹²⁵ China’s foreign minister has stated that to facilitate this, the initiative can align with both regional and individual ASEAN members’ development strategies in order to promote regional growth and cooperation.¹²⁶ President Xi Jinping has also promoted One Belt One Road on state visits to Vietnam and Singapore, emphasizing that the initiative will boost bilateral ties and facilitate trade and investment between China and Southeast Asian nations.¹²⁷

Chinese provincial governments are also actively promoting the initiative. Due to its location, China’s Guangdong province has a particular focus on the ASEAN region. The province has selected a number of projects with which to support the initiative. This includes a 5 million-ton oil refining project in Myanmar, a power plant project in Vietnam, and several banana plantations elsewhere in Southeast Asia.¹²⁸

“[One Belt One Road] is synonymous with peace, openness, inclusion and mutual understanding. All the countries alongside will benefit from it. This proposal shows China’s determination in boosting the interconnection of countries and the exchange among the people.”

**Cambodian Prime Minister,
Hun Sen (2015)**

Cambodian Prime Minister Hun Sen has stated: “[One Belt One Road] is synonymous with peace, openness, inclusion and mutual understanding. All the countries alongside will benefit from it. This proposal shows China’s determination in boosting the interconnection of countries and the exchange among the people.”¹²⁹ Senior officials from other ASEAN nations, including Thailand, Vietnam and Myanmar, have also expressed strong support for the initiative.

Despite this support, the initiative is complicated by the presence of significant maritime disputes in the South China Sea, especially China’s often tense disputes with Vietnam and the Philippines. However, One Belt One Road has been publicly welcomed by ASEAN ministers and officials from various nations. For example, the Chinese state media outlet *Xinhua* quoted one Lao official as saying that thanks to the

¹²⁵ *Ibid.*

¹²⁶ Xinhua (2015, 6 August), *China willing to align Belt and Road with ASEAN’s development strategies: FM*, Xinhua Finance. <http://en.xinfinance.com/html/OBAOR/Policy/2015/126470.shtml> (accessed May 2016).

¹²⁷ Xinhua (2015, 11 November), *China Focus: Belt and Road to boost China-ASEAN economic ties*, Xinhuanet. http://news.xinhuanet.com/english/2015-11/11/c_134804820.htm (accessed May 2016).

¹²⁸ Lin, J. (2015, 12 March), *China Headlines: China pools strength on Belt and Road strategy*, Xinhuanet. http://news.xinhuanet.com/english/2015-03/12/c_134062249.htm (accessed May 2016).

¹²⁹ Yao, C. (2015, 15 October), *Asian Political Parties’ Special Conference on the Silk Road opens in Beijing*, China People’s Daily Online. <http://en.people.cn/n/2015/1015/c98649-8962410.html> (accessed May 2016).

initiative and the planned China-Laos railway, Laos will transform from a land-locked country into a “land-linked” country.¹³⁰ In addition, as one of the first projects launched under the banner of One Belt One Road in Laos, China’s Yunnan Provincial Energy Investment Group opened a factory to produce cement specifically for the China-Laos railway and other major infrastructure projects under the initiative.¹³¹

There is nothing new about China’s desire to work with neighbouring countries to develop infrastructure connectivity, and many cross-border projects have already been developed or were under discussion or in construction at the time the initiative was first announced. However, One Belt One Road is likely to inject renewed energy to these efforts. Several major projects have recently been agreed between China and governments in the region, including multibillion-dollar railway projects in Laos and Indonesia. Although they have been planned for some time, these projects are now being referred to under the umbrella of One Belt One Road and highlighted as early successes of the initiative.

Financing for Projects Within the One Belt One Road

Projects within One Belt One Road will require billions of dollars in the coming years. Financing for these projects will come from a number of sources, many of which are not new. For example, China’s policy banks, including the China Development Bank, have been financing projects within what is now the One Belt One Road route for over a decade. China’s commercial banks are also active in many countries along the route, as are Chinese equity funds and investment companies. However, several of these entities have established new funds and received additional state money specifically to fund One Belt One Road projects. A number of dedicated funds have been established specifically for the initiative, the most well-known being the Silk Road Fund. China has also announced that it plans a considerable expansion of foreign aid programs, with a focus on transportation, energy and telecommunications projects in countries along the One Belt One Road route.¹³²

The table below provides an overview of some of the key actors that are likely to finance projects within One Belt One Road. This table focuses on those entities that are likely to be active in the ASEAN region, but is not exhaustive and there are many more actors that will be active within the initiative. The Silk Road Fund, China-ASEAN Infrastructure Investment Fund and China’s policy banks are discussed in more detail in later sections of the paper.

¹³⁰ Xinhua (2015, 27 July), *Spotlight: “Belt and Road” initiatives energize China’s neighborhood diplomacy*, Xinhuanet. http://news.xinhuanet.com/english/2015-07/27/c_134450308.htm (accessed May 2016).

¹³¹ Xinhua (2015, 3 December), *China-invested cement plant inaugurated in Laos to serve China-Laos railway construction*, Xinhuanet. http://europe.chinadaily.com.cn/business/2015-12/04/content_22626677.htm (accessed May 2016).

¹³² Li, X. (2014, 9 December), *China plans more aid for Silk Road countries’ infrastructure*, China Daily Online. http://www.chinadaily.com.cn/business/2014-12/09/content_19047154.htm (accessed May 2016).

Potential Sources of Finance for Projects within OBOR

Institution	Description	Institutional E&S standards ¹³³
Asian Infrastructure Investment Bank	Many AIIB members are within One Belt One Road. President Xi Jinping has personally encouraged the AIIB to “take part in the building of the Silk Road Economic Belt and 21st Century Maritime Silk Road.” ¹³⁴	Environmental and Social Framework
China’s policy banks	<p>China Development Bank: A policy bank providing medium- to long-term financing facilities that “assist in the development of a robust economy and a healthy, prosperous community.” Active across the world, with many projects falling within the One Belt One Road route.</p> <p>China Eximbank: A policy bank with a mission to facilitate export and import of Chinese products and equipment, assist Chinese companies’ overseas contracting and investment, and promote international economic cooperation and trade. Active across the world, with many projects falling within the One Belt One Road route.</p> <p>China Agricultural Development Bank: A policy bank with a mission to promote the development of agriculture and rural areas. Much less active overseas than the other policy banks, but there are indications the bank may support agriculture investment in One Belt One Road countries.</p>	<p>Internal policies for project evaluation and assessment (unpublished)</p> <p>Basic E&S guidelines with specific sections for domestic and overseas projects</p> <p>No published policies</p>
China’s “big four” state-owned commercial banks	Bank of China: Bank president stated in 2015 that it would focus overseas activities in ASEAN in order to push forward the One Belt One Road. ¹³⁵ The bank has a target of	All have internal policies dealing with issues including client and project assessment and green credit.

¹³³ China’s policy and commercial banks are also required to follow the China Banking Regulatory Commission’s Green Credit Guidelines.

¹³⁴ Xi J. (2016, 16 January), *President Xi Jinping’s address at AIIB inauguration ceremony*, Xinhuanet. http://news.xinhuanet.com/english/china/2016-01/16/c_135015661.htm (accessed May 2016).

¹³⁵ Xinhua Finance Agency (2015), *One Belt and One Road: Main Step*. http://en.xinfinance.com/html/OBAOR/Main%20Step/list_105_1.shtml (accessed May 2016).

	<p>channeling US\$100 billion to One Belt One Road projects in 2015-2017.¹³⁶</p> <p>Industrial and Commercial Bank of China: In 2015, the bank co-financed flagship One Belt One Road infrastructure projects in Pakistan alongside the Silk Road Fund, China Development Bank and China Eximbank.¹³⁷ In 2014, the bank signed an agreement with China Export & Credit Insurance Corporation to jointly promote One Belt One Road investment, including within Bangladesh-China-India-Myanmar Economic Corridor.¹³⁸</p> <p>Agricultural Bank of China: Less active overseas than China's other major commercial banks, but its presence is growing. The bank has stated that one of its priorities in the coming years will be to promote Chinese companies going out under One Belt One Road.¹³⁹ The bank signed a cooperation agreement with the Silk Road Fund.¹⁴⁰</p> <p>China Construction Bank: The bank signed an MOU with Singapore's overseas investment agency to invest over US\$22.2 billion in Singapore to channel to One Belt One Road projects.¹⁴¹</p>	<p>Some policies have been publicly released.</p>
--	---	---

¹³⁶ Jiang, X. (2015, August 21), *Bank of China boosts support for Belt and Road Initiative*, China Daily. http://europe.chinadaily.com.cn/business/2015-08/21/content_21666900.htm (accessed May 2016).

¹³⁷ Huo, K., Wang, L. & Wu, H. (2015, 17 June), *Investors Embrace China's Big Belt, Risky Road*, Caixin Online. <http://english.caixin.com/2015-06-17/100820036.html> (accessed May 2016).

¹³⁸ Industrial and Commercial Bank of China (2015, 3 August), *ICBC and SINOSURE to Promote "One Belt and One Road" Together*. <http://www.icbc.com.cn/icbc/newsupdates/icbc%20news/ICBCandSINOSUREtoPromoteOneBeltandOneRoadTogether.htm> (accessed May 2016).

¹³⁹ Agricultural Bank of China (2015, 12 March), *Agricultural Bank actively support Chinese enterprises to "go out"*. http://www.abchina.com/cn/aboutabc/newscenter/201503/t20150312_695593.htm (accessed May 2016).

¹⁴⁰ Agricultural Bank of China (2015, 1 April), *ABC Joins Hands with Silk Road Fund to Serve "One Belt and One Road"*. http://www.abchina.com/en/about-us/news/201504/t20150423_716345.htm (accessed May 2016).

¹⁴¹ Xinhua (2016, 25 April), *CCB, IE Singapore ink MOU to propel infrastructure projects under Belt and Road Initiative*, Xinhuanet. http://news.xinhuanet.com/english/2016-04/25/c_135310897.htm (accessed May 2016).

The Silk Road Fund	US\$40 billion investment fund established to support investment along the One Belt One Road. Capitalized by China's State Administration of Foreign Exchange (65%); China Investment Corporation (15%), China Eximbank (15%); China Development Bank (5%).	Unknown
China Insurance Investment Fund	Approved by the State Council in July 2015 but not yet operational. The US\$48 billion fund will be capitalized by Chinese insurance companies and will invest in China and overseas. According to the State Council it will actively invest in One Belt One Road projects. ¹⁴²	Unknown
China-ASEAN Investment Cooperation Fund	US\$1 billion investment fund targeting investment in infrastructure, energy, minerals and agricultural in ASEAN countries. The fund was set up several years prior to the announcement of One Belt One Road, but is likely to invest in projects within the initiative's route.	E&S guideline in place and published
Silk Road Gold Fund	Aims to raise 100 billion yuan (US\$16 billion) within five to seven years to invest in gold-related business and mining companies in countries along the Silk Road. The majority of the fund will be owned by Shandong Gold Group (35%) and Shaanxi Gold Group (25%), with the rest owned by financial institutions. ¹⁴³	Unknown
Green Ecological Silk Road Investment Fund	US\$4.8 billion equity fund established by group of private Chinese enterprises. ¹⁴⁴ Will focus on solar panel construction, clean energy and "ecological remediation" in China and other countries along the Silk Road Economic Belt. ¹⁴⁵	Unknown

¹⁴² State Council of the People's Republic of China (2015, 3 July), *Insurance investment fund application approved*.

http://english.gov.cn/policies/latest_releases/2015/07/03/content_281475139651494.htm; Xinhua (2015, 3 July), *China Approves Insurance Investment Fund*, Xinhuanet. http://news.xinhuanet.com/english/2015-07/03/c_134380202.htm (accessed May 2016).

¹⁴³ Campanella, M.L. & Jansen, K. (2015, 9 June), *The Redeployment of Asia's Forex Reserves*, Caixin Online. <http://english.caixin.com/2015-06-09/100817424.html> (accessed May 2016).

¹⁴⁴ Jiao, M. (2015, 9 March), *First PE fund for Green Silk Road launched in Beijing*, China.org.cn. http://china.org.cn/environment/2015-03/09/content_34997671.htm (accessed May 2016).

¹⁴⁵ China News (2015, 9 March), *China's Green Silk Road Fund Starts Operation*, CRIEnglish.com. <http://english.cri.cn/12394/2015/03/09/4061s869318.htm> (accessed May 2016).

Investment companies	<p>CITIC Limited: State-owned holding company with diversified investments across the globe. CITIC Limited claims it will invest US\$112 billion along the OBOR route in the next 10 years.¹⁴⁶</p>	Unknown
	<p>China Investment Corporation: Sovereign wealth fund responsible for managing a portion of China's foreign exchange reserves. Subsidiary CIC Capital plans to raise US\$50-100 billion for overseas investment, with a key focus on OBOR countries.¹⁴⁷ Contributed 15% of Silk Road Fund's initial capital.</p>	Unknown
	<p>China Minsheng Investment Corp: Private financial investment group. Established CMI International Holdings in Singapore with initial capital of \$1.5 billion to implement the OBOR agenda.¹⁴⁸</p>	Unknown

¹⁴⁶ Zhang, S. & Miller, M. (2015, 24 June), *China's CITIC to invest \$113 billion for "Silk Road" investments*, Reuters. <http://www.reuters.com/article/2015/06/24/china-citic-investments-idUSL3N0ZA3AH20150624> (accessed May 2016).

¹⁴⁷ Chen, J. (2015, 30 July), *Wealth fund banks on Belt and Road to drive growth*, China Daily Europe. http://europe.chinadaily.com.cn/business/2015-07/30/content_21446985.htm (accessed May 2016).

¹⁴⁸ The Jakarta Post (2015, 31 October), *China needs to gain trust for its 'one belt, one road' initiative*, Jakarta Post Online. <http://www.thejakartapost.com/news/2015/10/31/china-needs-gain-trust-its-one-belt-one-road-initiative.html> (accessed May 2016).

Chinese Investment Funds Operating in the ASEAN Region

Another important source of financing for China's overseas investment is state-backed investment funds. Various funds are active across the world, including in Africa, Latin America, Russia and Asia, usually with investment from the China Development Bank, China Eximbank and/or other state-backed entities. Two such investment funds that operate within the ASEAN region are the China-ASEAN Infrastructure Investment Fund and the newly-established Silk Road Fund, both of which have plans to expand operations in the coming years.

The Silk Road Fund

The US\$40 billion Silk Road Fund was established in December 2014 with the objective of promoting the “common development and prosperity of China and other countries and regions involved in the Belt and Road Initiative.”¹⁴⁹ The Silk Road Fund focuses on four broad areas:

- Infrastructure;
- Resources and energy development;
- Industrial capacity cooperation; and
- Financial cooperation.¹⁵⁰



The fund works with Chinese and international enterprises and financial institutions, mostly through equity investments, but may also provide loans and establish new funds in partnership with other Chinese and international institutions.¹⁵¹ In June 2016, the fund signed an agreement with the European Bank on Reconstruction and Development. Through this agreement the two parties agreed to boost cooperation and inform each other of future potential co-investment opportunities.¹⁵²

According to the Silk Road Fund's Articles of Association, it will focus on “major infrastructure development projects and projects that improve connectivity in the region.”¹⁵³ Senior Chinese officials have stated that the fund will operate in a similar way to a private equity fund, although it will invest for longer terms. The Governor of the People's Bank of China has compared the fund to the International Finance Corporation.¹⁵⁴

¹⁴⁹ Silk Road Fund (no date), *About Us*.

<http://www.silkroadfund.com.cn/enweb/23775/23767/index.html> (accessed May 2016).

¹⁵⁰ *Ibid.*

¹⁵¹ *Ibid.*

¹⁵² Pyrkalo, S. (2016, 15 June), *EBRD, Silk Road Fund agree to cooperate*.

<http://www.ebrd.com/news/2016/ebd-silk-road-fund-agree-to-cooperate.html> (accessed June 2016)

¹⁵³ Silk Road Fund (no date), *Articles of Agreement*.

<http://www.silkroadfund.com.cn/enweb/23786/23796/index.html> (accessed May 2016).

¹⁵⁴ Lu, J. (2015, 16 February), *China's \$40 bln Silk Road fund starts work along PE lines - PBOC's Zhou*, Reuters. <http://www.reuters.com/article/2015/02/16/china-silkroad-idUSL4N0VQ1WP20150216> (accessed May 2016).

Although at present it is entirely backed by institutions controlled by or linked to the Chinese state, the fund emphasizes that it works according to market principles and aims to ensure “reasonable returns” on its investments.¹⁵⁵ The fund has in place a board of directors and board of supervisors, which are both dominated by senior officials from Chinese ministries and state institutions, as well as the People’s Bank of China, China Development Bank, China Eximbank and China Investment Corporation.¹⁵⁶ The fund has a target of US\$40 billion and was established with an initial capital instalment of US\$10 billion, the majority of which came from China’s foreign currency reserves.¹⁵⁷

Initial Capital Contribution to Silk Road Fund (total US\$10 billion)

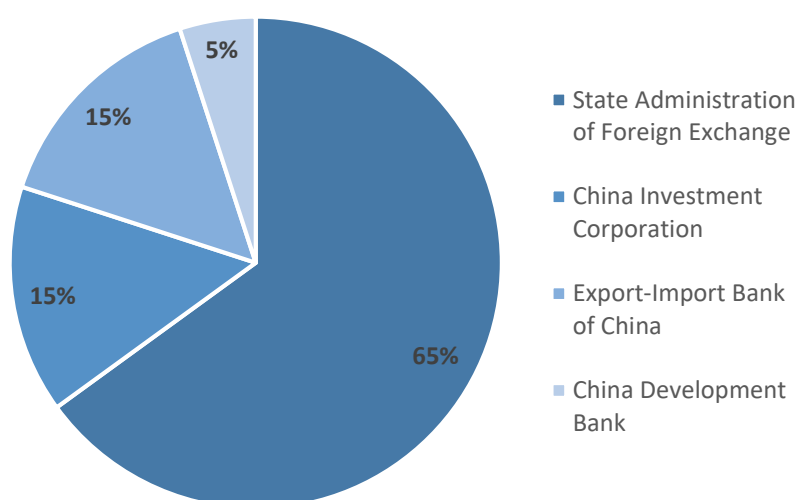

Silk Road Fund Environmental and Social Standards

The Silk Road Fund’s stated philosophy is of “openness, inclusiveness and mutual benefit.”¹⁵⁸ In its investment principles, the fund states that it strives to promote environmentally friendly and sustainable development,¹⁵⁹ and “respects international standards and norms, and follows the laws and regulations of China and the host countries.”¹⁶⁰ However, it is unclear what, if any, systems are in place regarding social and environmental assessments and mitigation. The fund has a committee that conducts risk management activities both prior to and after investments are finalized,¹⁶¹ but the extent to which this committee considers environmental and social

¹⁵⁵ Silk Road Fund (no date), *About Us*.

<http://www.silkroadfund.com.cn/enweb/23775/23767/index.html> (accessed May 2016).

¹⁵⁶ Silk Road Fund (no date), *Corporate Governance*.

<http://www.silkroadfund.com.cn/enweb/23786/23794/index.html> (accessed May 2016).

¹⁵⁷ Silk Road Fund (no date), *About Us*.

<http://www.silkroadfund.com.cn/enweb/23775/23767/index.html> (accessed May 2016).

¹⁵⁸ *Ibid.*

¹⁵⁹ Silk Road Fund (no date), *Investment Principles*.

<http://www.silkroadfund.com.cn/enweb/23798/23768/index.html> (accessed May 2016).

¹⁶⁰ Silk Road Fund (no date), *Scope of Investment*.

<http://www.silkroadfund.com.cn/enweb/23798/23805/index.html> (accessed May 2016).

¹⁶¹ Silk Road Fund (no date), *Risk Management*.

<http://www.silkroadfund.com.cn/enweb/23798/23807/index.html> (accessed May 2016).

risks when assessing potential investments is unclear. There is no mechanism through which complaints can be filed by people who feel they have been negatively impacted by a Silk Road Fund-associated project.

The Silk Road Fund launched a Chinese and English website in November 2015. The information it provides is relatively basic, and although the news section provides updates on the fund's activities, there is no detailed list of investments. While project details are basic, the site is more comprehensive than that of any other Chinese state-backed investment fund. However, the fund does not appear to have an information disclosure policy, and there is no formal mechanism through which the public can request project information.

The fund's first project was the Karot hydropower dam in Pakistan. The fund subsequently signed MOUs with various state-owned banks and funds, acquired equity in several companies, and supported Chinese state-owned firms to list on the Hong Kong Stock Exchange. The fund has only been operational for a short time, but the investments and agreements it has already finalized provide an indication of how the fund is likely to focus its activities in the future. In a meeting in April 2016, the Silk Road Fund met with Cambodia's Minister of Foreign Affairs and discussed ideas for cooperation.¹⁶²

¹⁶² Silk Road Fund (2016, 27 April), *President Wang Yanzhi Meets with Minister Prak Sokhonn of Foreign Affairs and International Cooperation of Cambodia*.
<http://www.silkroadfund.com.cn/enweb/23809/23812/32722/index.html> (accessed May 2016).

Highlights of Silk Road Fund Invested Projects (Up to May 2016)¹⁶³

Country	Project / Agreement
Pakistan (Equity and loan)	Silk Road Fund became a shareholder in China Three Gorges South Asia Investment Ltd (CTGSAIL), which is developing the 3,350MW Karot hydropower dam at an estimated cost of US\$1.65 billion. The International Finance Corporation (IFC) also holds equity in CTGSAIL. Financing for the project will be provided by a consortium of the Silk Road Fund, China Eximbank, China Development Bank and the IFC. ¹⁶⁴
Russia (Equity and loan)	The fund acquired a 9.9% equity stake in the Yamal liquefied natural gas project in Russia worth an estimated US\$2 billion. Shares in the project were acquired from Russian company Novatek. The fund and Novatek also signed an agreement for a EUR730 million loan to support project development.
Hong Kong (Equity)	The fund agreed to purchase US\$300 million of shares in the initial public offering of state-owned China Energy Engineering Corp on the Hong Kong stock exchange. ¹⁶⁵ The company's subsidiaries are active across Southeast Asia and around the world.
Hong Kong (Equity)	The fund backed the Hong Kong initial public offering of state-owned investment banking group China International Capital Corporation, purchasing US\$100 million of company shares. ¹⁶⁶ The company plans to raise US\$50-100 billion for overseas investment, with One Belt One Road countries a key focus.
Saudi Arabia (MOU)	The fund signed a memorandum of understanding with Saudi company ACWA Power to make equity investments and provide debt financing to a gas/oil power station in Egypt and a coal power plant in UAE. The International Finance Corporation holds equity in ACWA Power, which is also developing a coal plant in Vietnam.

¹⁶³ Silk Road Fund (no date), *News and Press Releases*.

<http://www.silkroadfund.com.cn/enweb/23809/23812/index.html> (accessed May 2016).

¹⁶⁴ Silk Road Fund (2015, 20 April), *Q&A About the Silk Road Fund's First Project Investment*.

<http://www.silkroadfund.com.cn/enweb/23809/23812/23942/index.html> (accessed May 2016).

¹⁶⁵ Hu, F. (2015, 25 November), *China Energy Engineering Draws Silk Road, GE to \$2 Billion IPO*, Bloomberg. <http://www.bloomberg.com/news/articles/2015-11-25/china-energy-engineering-draws-silk-road-ge-to-2-billion-ipo> (accessed May 2016).

¹⁶⁶ China Daily (2015, 27 October), *Silk Road Fund to invest \$100m in Chinese company's IPO*, China Daily. http://usa.chinadaily.com.cn/business/2015-10/27/content_22295987.htm (accessed May 2016).

China-ASEAN Investment Cooperation Fund

The China-ASEAN Investment Cooperation Fund received state approval in 2013. The fund is under the direction of China's State Council.¹⁶⁷ It targets investments in infrastructure, energy and natural resources in ASEAN countries.

China-ASEAN Investment Cooperation Fund Investment Areas¹⁶⁸

Sector	Examples
Infrastructure	Toll roads, railways, container ports, airports Telecommunication Water and wastewater Oil and gas pipelines Social infrastructure
Energy / Power	Conventional energy Renewable energy
Natural Resources	Industrial metals (ferrous and non-ferrous metals) Precious metals (gold, palladium, platinum and silver) Agro-industry (palm oil, pulp and rubber)

The fund's mission is to maximize returns for investors and strengthen cooperation between ASEAN and China in order to enable mutual development.¹⁶⁹ As can be seen above, the fund seeks to promote investment in sectors similar to those targeted by the AIIB, and the chief executive of the fund has referred to the fund as a forerunner of the One Belt One Road initiative.¹⁷⁰

As discussed throughout this paper, in promoting outbound investment, China aims to address infrastructure gaps, while also promoting its broader economic and strategic goals. In the case of the China-ASEAN Investment Cooperation Fund, this includes deepening cooperation between China and ASEAN. The fund uses familiar language of "mutual" development when describing its operations. For example, when announcing the fund's investment in a potash mine in Laos, the chairman stated that the project was strategically important for the host country, while also supporting

¹⁶⁷ China-ASEAN Investment Cooperation Fund (no date), *About CAF: Background*. <http://www.china-asean-fund.com/about-caf.php?slider1=2> (accessed May 2016).

¹⁶⁸ China-ASEAN Investment Cooperation Fund (no date), *Investment: Target Areas*. <http://www.china-asean-fund.com/investment.php?slider1=2> (accessed May 2016).

¹⁶⁹ China-ASEAN Investment Cooperation Fund (no date), *About CAF: Mission & Vision*. <http://www.china-asean-fund.com/about-caf.php?slider1=1> (accessed May 2016).

¹⁷⁰ Jiang, X. (2015, 26 January), *Fund to foster economic ties with ASEAN*, China Daily USA. http://usa.chinadaily.com.cn/epaper/2015-01/26/content_19409699.htm (accessed May 2016).

Chinese companies 'going out' and addressing the potash supply shortage in China.¹⁷¹ Likewise, an investment in digital TV Cambodia was described as an opportunity to upgrade local technology while also opening the Cambodian market to Chinese investors.¹⁷²

The China-ASEAN Investment Cooperation Fund was established with an initial US\$1 billion but has a target of raising US\$10 billion. The China Eximbank led the formation of the fund and was the main sponsor, contributing US\$300 million of its starting capital. The World Bank's International Finance Corporation holds equity in the fund and contributed US\$100 million (or 10%) of the phase one funding.¹⁷³ Several other institutions, including the China Investment Corporation and Bank of China, have a stake in the fund and its management.¹⁷⁴ The CEO of the fund is Li Yao, former principle investment officer at the International Finance Corporation's Asia and Pacific division.¹⁷⁵

The fund's typical investment size is US\$50-100 million, and it mostly invests through equity deals.¹⁷⁶ At least 20% of its first phase funds were allocated to investments in Indonesia.¹⁷⁷ According to the fund's CEO, over 30% of the remaining investment went to Cambodia, Myanmar, Laos and Vietnam, with the rest spread across Southeast Asia.¹⁷⁸ During its first phase, the fund invested in 11 projects. Unfortunately, the fund's website only provides summaries of the investments, with limited project details, and no information on the terms or value of each investment.

¹⁷¹ China-ASEAN Investment Cooperation Fund (no date), *CAF Invests into Asia's Largest Potash Mine in Lao PDR*. <http://www.china-asean-fund.com/news-detail.php?id=15> (accessed November 2015).

¹⁷² China-ASEAN Investment Cooperation Fund (no date), *CAF Invests into Cambodia's Smart TV Project*. <http://www.china-asean-fund.com/news-detail.php?id=15> (accessed November 2015).

¹⁷³ International Finance Corporation (2010, 25 January), *China-ASEAN Fund on Investment Cooperation: Summary of Proposed Investment*. <http://ifcext.ifc.org/ifcext/spiwebsite1.nsf/0/EA30D66D3BCEE0F9852576BA000E3309> (accessed May 2016).

¹⁷⁴ Li, Y. (2014, 30 June), *Chinese investment fund aims to spread wealth, sustainability in Asean*, Nikkei Asian Review. <http://asia.nikkei.com/Business/Executive-Lounge/Chinese-investment-fund-aims-to-spread-wealth-sustainability-in-Asean> (accessed May 2016).

¹⁷⁵ World Economic Forum, *Profile: Li Yao*. <http://www.weforum.org/global-agenda-councils/li-yao> (accessed May 2016).

¹⁷⁶ China-ASEAN Investment Cooperation Fund (no date), *Investment: Investment Approach*. <http://www.china-asean-fund.com/investment.php?slider1=1> (accessed May 2016).

¹⁷⁷ China-ASEAN Investment Cooperation Fund (no date), *Sub-Fund*, CAF website. <http://www.china-asean-fund.com/sub-fund-1.php> (accessed May 2016).

¹⁷⁸ Li, Y. (2014, 30 June), *Chinese investment fund aims to spread wealth, sustainability in Asean*, Nikkei Asian Review. <http://asia.nikkei.com/Business/Executive-Lounge/Chinese-investment-fund-aims-to-spread-wealth-sustainability-in-Asean> (accessed May 2016).

First Phase Investments (up to May 2014)¹⁷⁹

Country	Sector	Project
Cambodia	Telecoms	Invested in Chinese-owned company Cambodia Fiber Optic Communication Network to support development of fiber optic network and telecommunication services.
Cambodia	Telecoms	Co-invested in digital TV network project in Cambodia with Chinese partner Shenzhen Coship Electronics.
Thailand	Shipping	Equity investment in the Laem Chabang Port, a hub for regional maritime trade.
Thailand	Energy	Acquired equity in Thai company National Power Supply Public Co. Ltd. in order to support development of biomass energy generation project.
Laos	Mining	Invested in Chinese-owned Asia Potash Group, which is developing a potash mine. Asia Potash is predicted to become the largest potash producer in Asia.
Malaysia	Mineral resources	Investment in Hong Kong listed company Prosperity International Holdings, which is developing Gebang Iron Ore Processing Plant in Malaysia. <i>Note: The fund divested in February 2014.</i>
Philippines	Transport	Acquired controlling stake in Negros Navigation, involved in transport between islands of the Philippines.
Indonesia	Smelting	Signed investment and financing agreement to develop a smelter with Shanghai Decent Investment Group Co. Ltd. and Indonesian firm PT Bintangdelapan Investama.
Indonesia	Telecoms	Invested in telecom tower operator in order to support company's business expansion and promote industrial upgrade.
Southeast Asia	Healthcare	Equity investment to support buyout of chain of healthcare clinics and support acquisitions to build regional healthcare platform. <i>Note: The fund divested in November 2014.</i>
China	Equipment export	Signed MOU with China's Jidong Development Group. Parties plan to transfer 10 million tons of Chinese cement production from China to ASEAN in the next three years through projects in Malaysia, Vietnam and Myanmar.

¹⁷⁹ China-ASEAN Investment Cooperation Fund (no date), *News & Press Release*. <http://www.china-asean-fund.com/news.php?slider1=1> (accessed November 2015).

The second phase of funding will be in place within the next two years, and China is seeking to raise an additional US\$3 billion.¹⁸⁰ Within ASEAN, the fund will focus its future investments on mainland Southeast Asia and Indonesia.¹⁸¹

China-ASEAN Investment Cooperation Fund's Environmental and Social Standards

Like many other investment funds, the China-ASEAN Investment Cooperation Fund claims to have a set of “core values” that guide its investments. These stated values include social responsibility and sustainable development.¹⁸² The fund also states that it “specializes in sustainable investments that not only bring financial growth to the investee company but also significant values to the community.”¹⁸³ However, as noted above, the fund is targeting a number of very high-risk areas, including mining, energy and agro-industry. In the agriculture sector, the fund specifically highlights palm, pulp and rubber – all of which are associated with severe social and environmental impacts across the ASEAN region. Due to the high-risk nature of these investments, appropriate social and environmental policies are crucial.

In order to secure the International Finance Corporation's investment, the fund was required to put in place an environmental and social management system and commit to ensuring that the International Finance Corporation's Performance Standards are applied to the fund's investments.¹⁸⁴ One of the stated objectives of the International Finance Corporation's involvement was to influence the fund to implement the Equator Principles (which mirror the Performance Standards).¹⁸⁵

The China-ASEAN Investment Cooperation Fund has established what it describes as a comprehensive environmental and social management system, and claims that this system is an integral process of the investment team's evaluation and selection of investment opportunities:

From the very outset of the deal flow, [the fund] carefully assess a prospect's guiding values and business practices to ensure a sound alignment with our own values. During the subsequent due diligence stage, [the fund] carefully considers a company's E&S past and existing performance against the Fund's own E&S standards. The aim

¹⁸⁰ Li, K (2015, 13 November), *Remarks by H.E. Li Keqiang Premier of the State Council of the People's Republic of China At the 17th ASEAN-China Summit*, Ministry of Foreign Affairs of the People's Republic of China. http://www.fmprc.gov.cn/mfa_eng/zxxx_662805/t1212266.shtml (accessed May 2016).

¹⁸¹ Jiang, X. (2015, 26 January), *Fund to foster economic ties with ASEAN*, China Daily USA. http://usa.chinadaily.com.cn/epaper/2015-01/26/content_19409699.htm (accessed May 2016).

¹⁸² China-ASEAN Investment Cooperation Fund (no date), *About CAF: Mission & Vision*. <http://www.china-asean-fund.com/about-caf.php?slider1=1> (accessed May 2016).

¹⁸³ *Ibid.*

¹⁸⁴ International Finance Corporation (2010, 25 January), *China-ASEAN Fund on Investment Cooperation: Summary of Proposed Investment*. <http://ifcext.ifc.org/ifcext/spiwebsite1.nsf/0/EA30D66D3BCEE0F9852576BA000E3309> (accessed May 2016).

¹⁸⁵ International Finance Corporation (2010, 25 January), *China-ASEAN Fund on Investment Cooperation: Summary of Proposed Investment*. <http://ifcext.ifc.org/ifcext/spiwebsite1.nsf/0/EA30D66D3BCEE0F9852576BA000E3309> (accessed May 2016).

is to ensure investee companies have appropriate capacity for E&S management and are operating their business in a sustainable manner.¹⁸⁶

In July 2014, the fund issued the *Social Responsibility and Environmental Protection Guidelines for Investments in the ASEAN Region*. The guidelines were drafted and issued jointly by the fund and the ASEAN-China Centre, an information center set up by China and ASEAN member states. All companies and projects that receive investment from the fund are required to “accept and execute” the guidelines. Additionally, Chinese companies operating in ASEAN are encouraged to “refer” to them.¹⁸⁷

The fund’s social and environmental guidelines are contained in a relatively brief 15-page document, which includes basic details on its investment principles and procedure, performance standards, evaluation and performance monitoring, and post-investment management. Although the overall content of the guidelines is basic, the document includes an annex that states: “[the fund] adopts the Performance Standards on Environmental and Social Sustainability issued by International Financial Corporation (IFC) of the World Bank Group to manage and assist target companies to achieve best performance.”¹⁸⁸ The guidelines include the International Finance Corporation’s eight Performance Standards that its clients are required to meet during the life of a fund investment.¹⁸⁹ It also includes an annex on project categorization that utilizes a similar system and criteria to the International Finance Corporation, using Categories A, B and C for high-, medium- and low-risk projects.¹⁹⁰

According to the CEO of the China-ASEAN Investment Cooperation Fund, the International Finance Corporation’s involvement has strengthened the fund’s dedication to sustainable investment and helped set a benchmark for future projects.¹⁹¹ The adoption and publication of the fund’s guidelines represent a step forward in social and environmental governance that no other Chinese-led funds have taken to date.

Although the fund has published environmental and social guidelines, there is still very little information available regarding specific projects, and no documents have been published regarding assessments or evaluation of specific fund investments. Thus, the

¹⁸⁶ China-ASEAN Investment Cooperation Fund (no date), *Responsible Investing*. <http://www.china-asean-fund.com/responsible-investing.php> (accessed May 2016).

¹⁸⁷ China-ASEAN Investment Cooperation Fund (2014, 5 July), *CAF and ASEAN-China Center Jointly Issued the Social Responsibility and Environmental Protection Guidelines for Investments in the ASEAN Region*. <http://www.china-asean-fund.com/news-detail.php?id=20> (accessed May 2016).

¹⁸⁸ ASEAN-China Centre & China-ASEAN Investment Cooperation Fund (2014), *Social Responsibility and Environmental Protection Guidelines for Investments in the ASEAN Region*, appendix C. http://www.china-asean-fund.com/files/publication/20140709150739_166.pdf (accessed May 2016).

¹⁸⁹ The eight standards are: Assessment and Management of Environmental and Social Risks and Impacts; Labour and working conditions; Resources efficiency and pollution prevention; Community health, safety and security; Land acquisition and involuntary resettlement; Biodiversity conservation and sustainable management of living natural resources; Indigenous people; and Cultural heritage.

¹⁹⁰ ASEAN-China Centre & China-ASEAN Investment Cooperation Fund (2014), *Social Responsibility and Environmental Protection Guidelines for Investments in the ASEAN Region*, appendix D. http://www.china-asean-fund.com/files/publication/20140709150739_166.pdf (accessed May 2016).

¹⁹¹ Li, Y. (2014, 30 June), *Chinese investment fund aims to spread wealth, sustainability in Asean*, Nikkei Asian Review. <http://asia.nikkei.com/Business/Executive-Lounge/Chinese-investment-fund-aims-to-spread-wealth-sustainability-in-Asean> (accessed May 2016).

effectiveness of the environmental and social management system remains an open question, as does the extent to which the fund is diligently ensuring that Performance Standards are met in each of its projects and investments.

The fund does not appear to have established a complaints mechanism to help ensure accountability to the Performance Standards, despite the establishment of such a mechanism being a requirement of International Finance Corporation policy.¹⁹² Thus, if project-affected people suffer harm from fund projects, they do not appear to have recourse through a formal mechanism. However, because of the International Finance Corporation's 10% stake in the fund, they can submit a complaint to the its accountability mechanism, the Compliance Advisor Ombudsman, and attempt to have their grievances addressed through its compliance review or dispute resolution functions.



*Stanari Coal Project, Bosnia and Herzegovina,
financed by China Development Bank
(Photo by Friends of the Earth US)*

¹⁹² International Finance Corporation (2012, 1 January), *Policy on Environmental and Social Sustainability*, paragraph 54.

China's Policy Banks: Financiers of the Going Out Strategy

So far this paper has examined the more recent developments in Chinese outbound infrastructure finance. However, China's policy banks have already been operating overseas for more than a decade in support of the Going Out strategy. These institutions have created the foundation for China's rapid ascent to one of the world's top investors.¹⁹³ As mentioned earlier, the policy banks have expressed strong enthusiasm for supporting the One Belt One Road strategy.

China's policy banks were set up in the mid-1990s in order to separate policy-oriented finance from commercial finance. There are three policy banks: China Development Bank, the China Eximbank and the Agricultural Development Bank of China.¹⁹⁴ Creating these banks allowed China's "big four" state-owned commercial banks (Bank of China, China Construction Bank, Agricultural Bank of China, and Industrial and Commercial Bank of China) to focus more on commercial operations.¹⁹⁵ The China Development Bank and Export-Import Bank in particular have been major drivers of the Going Out strategy, investing billions of dollars overseas. As policy banks, their role is to support the policy objectives of the Chinese government, and both banks will therefore play a crucial role in financing projects within One Belt One Road. Since the announcement of the One Belt One Road initiative, the Chinese government has injected significant amounts of capital into both banks. According to financial media reports, between April and August 2015, the central bank provided the China Development Bank with US\$94 billion of foreign exchange and Eximbank with US\$90 billion to support overseas projects.¹⁹⁶

China Development Bank

The China Development Bank provides medium- to long-term financing for activities and projects that align with China's national



国家开发银行
CHINA DEVELOPMENT BANK

economic strategy. In China, this includes infrastructure, industry, and other national priority projects. It also provides financing to education, healthcare, agriculture, low-income housing and environmental initiatives.¹⁹⁷ The bank plays a major role in facilitating China's overseas investment. In 2014, it issued over US\$100 billion in

¹⁹³ Kyngé, J. (2016, 18 May), *China becomes global leader in development finance*, Financial Times. <http://www.ft.com/intl/cms/s/3/b995cc7a-1c33-11e6-a7bc-ee846770ec15.html> (accessed May 2016).

¹⁹⁴ Research Academy of China Development Bank (2011), *China Development Bank Practice and Achievements of Development Finance*, Beijing: Democracy and Construction Press.

¹⁹⁵ Erica Downs (2011), *Inside China, Inc.: China Development Bank's Cross-Border Energy Deals*, Washington DC: Brookings Institution, p.12.

¹⁹⁶ Zhang, Y. (2015, 21 July), *Policy Banks Linked to 'Belt and Road' Plans Said to Get US\$ 31 Bln*, Caixin Online. <http://english.caixin.com/2015-07-21/100831133.html> (accessed May 2016); Xinhua (2015, 18 August), *China raises capital base of development bank*, Xinhuanet. http://europe.chinadaily.com.cn/business/2015-08/18/content_21640335.htm (accessed May 2016).

¹⁹⁷ China Development Bank (2015), *Annual Report 2014*, Beijing: CDB.

foreign currency loans.¹⁹⁸ By way of comparison, the World Bank Group lent US\$61 billion in 2014.¹⁹⁹

Domestically, the China Development Bank has supported mega projects such as the Three Gorges Dam, the South-North Water Transfer Project, and numerous power grids, road and high-speed railway projects. In ASEAN, the bank has provided finance to the controversial China-Myanmar gas pipeline, the Vung Ang coal power plan in Vietnam and Stung Atai hydropower dam in Cambodia; provided scholarships for students from Laos to study in China; and signed a memorandum of understanding with Thailand's investment board to promote bilateral investment, among many other projects.

As discussed above, China's central bank made major foreign currency investments in the China Development Bank in 2015, which will be utilized for overseas investment. One Belt One Road will be a "strategic focus" as the bank continues to develop its international business.²⁰⁰ The bank provided 5% of the Silk Road Fund's initial capital and also has specific funds for ASEAN infrastructure investment. For example, in 2014, Chinese Premier Li Keqiang pledged US\$20 billion to support connectivity between China and Southeast Asia. This included a preferential loan of US\$10 billion to ASEAN members and a US\$10 billion special loan set up by the China Development Bank for regional infrastructure development.²⁰¹

China Development Bank Environmental and Social Standards

The China Development Bank claims to have in place standards for managing the environmental and social impacts of its activities. However, it has only published summaries and the full documents are not public. The only information available on these policies is contained within bank reports from recent years. According to these summaries, the bank's project assessments include an appraisal of the environmental and social risks of proposed projects. Loan applications must include environmental impact assessments, and the bank can reject loans on environmental grounds. Importantly, the bank can write environmental standards and costs into loan covenants in order to oblige borrowers to carry out their environmental commitments.²⁰² The China Development Bank is also a member of the UN Global Compact and the UN Environmental Program Finance Initiative. While it has not signed up to the Equator Principles, it has established an internal Equator Principles working group and claims that the principles are being gradually applied in its business development.²⁰³

¹⁹⁸ *Ibid.*, p.12.

¹⁹⁹ World Bank (2014, 1 July), *World Bank Group Commitments Rise Sharply in FY14 Amid Organizational Change*. <http://www.worldbank.org/en/news/press-release/2014/07/01/world-bank-group-commitments-rise-sharply-in-fy14-amid-organizational-change> (accessed May 2016).

²⁰⁰ *Ibid.*, p.17.

²⁰¹ Xinhua (2014, 13 September), *China pledges over 20-bln-USD loans to boost Southeast Asian connectivity*, Xinhuanet. http://news.xinhuanet.com/english/china/2014-11/13/c_133787970.htm (accessed May 2016).

²⁰² Matisoff, A. (2012), *China Development Bank's Overseas Investments: An assessment of environmental and social policies and practices*, Berkeley: Friends of the Earth. <http://www.foe.org/news/archives/2012-07-new-report-on-china-development-bank-shows-the-bank>.

²⁰³ China Development Bank (2013, 7 August), *Tightening EIA to Promote Multilateral Win-Win Outcome – CDB's "Green Credit" Goes to the World*. <http://www.cdb.com.cn/english/NewsInfo.asp?NewsId=4715> (accessed May 2016).

While the bank has made commitments to work towards implementing the Equator Principles in its operations and has in place internal standards for managing environmental and social risks, the assessment process is not transparent. The bank publishes no documents on specific projects, and there is no grievance mechanism or official communication channel for potentially affected people. The bank's website does not provide a comprehensive list of projects. This lack of transparency greatly limits the effectiveness of any social and environmental policies that may currently be in place. However, concerned parties can refer to them in communications and advocacy around bank-funded projects.

Export-Import Bank of China

The China Eximbank was established to promote and facilitate the export and import of Chinese products, assist Chinese companies in offshore



中国进出口银行

THE EXPORT-IMPORT BANK OF CHINA

project contracting and outbound investment, and promote international economic cooperation and trade.²⁰⁴ Much like the China Development Bank, the Eximbank is a major supporter of Chinese firms going out and is involved in projects all over the world. In 2014, the bank dispersed RMB 921 billion (US\$142 billion) in loans.²⁰⁵ Much of this lending is focused on infrastructure, industry and trade, including shipping, transport infrastructure, oil and gas, energy, telecommunications, manufacturing, and agriculture projects. Most of the Eximbank's lending is commercial, but the bank is also responsible for China's concessional lending. Concessional lending refers to loans and credits with below-market interest rates and lengthy repayment periods, which account for the majority of China's overseas aid.²⁰⁶

Supporting connectivity with neighboring countries is a key focus of the Eximbank. The bank states that it "pursues business development in keeping with China's new diplomatic strategies," including One Belt One Road.²⁰⁷ The bank is an important financial actor in ASEAN, where it has provided financing to projects including the Kamchay hydropower dam in Cambodia, the Bac Giang-Lang Son highway and Vin Than coal power plant in Vietnam; multiple dams and transmission systems in Laos; microfinance in Myanmar; and high-end residential developments in Bangkok, Thailand. The Eximbank is the top funder and manager of the China-ASEAN Investment Cooperation Fund. The bank is also heavily involved in China's regional railway investment. In late 2015, the bank signed a lending agreement with the state-owned China Railway Corporation to support its overseas expansion. This agreement

²⁰⁴ Export-Import Bank of China, *Brief Introduction*. http://english.eximbank.gov.cn/tm/en-TCN/index_617.html (accessed May 2016).

²⁰⁵ Export-Import Bank of China (2014), *Annual Report 2014*, Beijing: China Eximbank.

²⁰⁶ Grimsditch, M. & Yu, Y. (2015), *Development Finance in the BRICS Countries: A Review from China*, New Delhi: Heinrich Böll Foundation. https://za.boell.org/sites/default/files/development_finance_in_brics_countries.pdf (accessed May 2016).

²⁰⁷ Export-Import Bank of China (2014), *Annual Report 2014*, Beijing: China Eximbank.

includes a line of credit of up to 500 billion yuan (almost US\$80 billion). The China Railway Corporation is involved in proposed railway development projects in Indonesia, Laos and Thailand, which may all receive Eximbank loans through this agreement.²⁰⁸

Eximbank Environmental and Social Standards

The Eximbank has done more than most Chinese financial institutions to disclose its social and environmental standards and policies. The bank has a basic policy in place called the Guidelines for Environmental and Social Impact Assessments of the China Export and Import Bank's Loan Projects. The guidelines relate to both domestic and overseas projects and cover project appraisal, environmental assessment, loan management and supervision. The guidelines state that borrowers must follow local environmental laws and regulations when investing overseas. In cases where local systems and regulations are inadequate, borrowers are instructed to implement Chinese standards or "international practices."²⁰⁹

Eximbank guidelines also briefly mention land and resource rights and state that resettlement must be handled appropriately, and that projects with severe impacts should be open to public consultation. Eximbank has the power to inspect projects during implementation, and if serious impacts emerge during project development or operation, the bank may cease loan disbursement and demand early repayment if the borrower does not take adequate measures to address the problems.²¹⁰ It has also been reported that Eximbank can request that clients rectify behaviour, freeze unused credit, issue warnings, adopt restrictions on business, and establish credit exit mechanisms if borrowers do not comply.²¹¹

Eximbank also adopted a much more detailed Environmental Assessment Framework and a Resettlement Policy Framework in 2011 for implementation in a World Bank-financed project in China. However, it is not clear to what extent these policies are applied in overseas projects. Although the 2007 environmental and social guidelines do explicitly address overseas projects and touch on a number of key issues, the document is basic and consists of only 21 brief articles. There are no formal avenues through which the public can request information on specific projects and no formal grievance mechanisms. Project assessment is not open, and no project documents are published by the bank. As is the case with the China Development Bank, these shortcomings significantly reduce the effectiveness of the guidelines, but they can still be a useful reference point for communities and civil society groups seeking to engage with the bank or conduct advocacy around Eximbank-funded projects.

²⁰⁸ Xinhua (2015, 19 November), *China EximBank to finance China Railway's global projects*, Xinhuanet. http://news.xinhuanet.com/english/2015-11/19/c_134834239.htm (accessed May 2016).

²⁰⁹ Export-Import Bank of China (2008), *Guidelines for Environmental and Social Impact Assessments of the China Export and Import Bank's Loan Projects*.

²¹⁰ *Ibid.*

²¹¹ Friends of the Earth US (2016), *Emerging Sustainability Frameworks: China Development Bank and China Export-Import Bank*, Washington DC: FOE. <http://www.foe.org/projects/economics-for-the-earth/international-finance/emerging-sustainability-frameworks>.



*Sinohydro's Kamchay dam in Cambodia, financed by China Eximbank
(Photo by Inclusive Development International)*

Implications for Infrastructure Financing in the ASEAN Region

China has been a significant actor in global infrastructure financing for several years. Its policy and commercial banks and state-backed investment funds have been supporting outbound infrastructure investment for over a decade, but the recent establishment of the major institutions and initiatives discussed here herald an even larger presence for China in global development finance. The AIIB is the first Chinese-initiated multilateral financial institution, and it is promoting itself as a new model, with a management and governance structure that is more streamlined, more efficient and well suited to Asia's needs. The One Belt One Road initiative reflects a renewed emphasis from China on promoting outbound investment, especially in projects that enhance regional connectivity. Dedicated funds have been created to support One Belt One Road, and existing institutions and companies have been quick to express their support and announce plans to increase investment and financing in projects along its route.

With the renewed support from the Chinese state and ongoing relaxation of regulations on outbound investment, there is potential for Chinese overseas investment to increase considerably. This has potentially significant implications for the ASEAN region and beyond.

Increased Access to Infrastructure Financing: New Risks or New Opportunities?

Asia faces a significant shortfall in funding for infrastructure projects. The governments of most ASEAN countries are clearly eager to attract investment in large-scale infrastructure projects, especially in transport, energy and other projects that facilitate interconnectivity. The AIIB and other initiatives discussed here will contribute to addressing this need. Undoubtedly this increased access to financing is welcomed by many nations, as evidenced by the rapid pace at which membership in the AIIB grew.

Although it is generally accepted that there is a global shortfall in accessible infrastructure financing, there is another side to this discussion: the lack of *bankable* infrastructure projects, i.e. projects that are well-prepared, financially viable and guarantee returns. While there is clear demand for more infrastructure, financiers are often reluctant to become involved in projects that have not been through rigorous screening and assessment processes, or which may not provide a reliable source of future revenue through which loans can be repaid. Major projects in high-risk countries, such as those with weak governance or conflict, can also struggle to secure funding.²¹² This is an issue that the AIIB and other institutions mentioned here will have to address, and one motivation behind the AIIB establishing its project preparation fund was to respond to this challenge.

The AIIB has not yet started lending, but concerns have been raised that the bank will support high-risk projects that have been passed over by other international financial

²¹² The Economist (2015, 26 September), *Reversion to the mean: China's new infrastructure bank has gained wide support. Lending will be tougher.* <http://www.economist.com/news/asia/21667964-chinas-new-infrastructure-bank-has-gained-wide-support-lending-will-be-tougher-reversion> (accessed January 2016).

institutions, such as coal and large-scale hydropower. Vietnam and Myanmar have ambitious plans for development of coal-fired power plants, while Cambodia and Laos have prioritized large-scale hydropower, often with the support of Chinese investors. It can be expected that these countries will seek funding from the AIIB to support the roll out of national energy plans, which include these controversial projects. It remains to be seen if the AIIB will take on projects deemed too risky by other international financial institutions. The AIIB is developing an energy policy, but until this is released, it is not clear what type of energy projects it will support. The One Belt One Road initiative has already been linked to a number of mega-projects, including the massive Karot hydropower dam in Pakistan and various fossil fuel projects elsewhere in Asia.

At the same time, there is also significant scope for Chinese finance to be directed to green investments. China is a major investor in renewable forms of energy such as wind and solar, both at home and overseas. A stated goal of the AIIB is to foster “sustainable economic development.” Likewise, the core values of the Silk Road Fund and China-ASEAN Investment Cooperation Fund include commitments to sustainability. If funding from these institutions is directed to genuinely sustainable and inclusive development projects, the benefits could be considerable.

Social and Environmental Standards of Chinese Financiers

The social and environmental safeguards of Chinese financiers are generally basic and are often not open to public view and scrutiny. Although the available information varies, none of the bilateral financiers discussed in this paper publish extensive project documentation, and none have grievance or accountability mechanisms in place.

The weakness of environmental and social governance is especially true for China’s policy banks. The Eximbank’s guidelines are very brief, and the guidelines of the China Development Bank have not been published. The Chinese-ASEAN Investment Cooperation Fund has a more advanced set of environmental and social standards and systems, due to the International Finance Corporation’s shareholding in the fund. As for the AIIB, the Environmental Safeguard Framework represents a step forward in comparison to China’s bilateral financial institutions, but civil society groups still have concerns about crucial gaps in the framework. In line with its stated aim of being a “lean” institution, it is clear that the AIIB is consciously seeking to reduce bureaucracy in its structure, management and governance. This is also reflected in the stripped-down safeguards and the extremely brief public consultation period.

There are a number of state-issued guidelines that apply to all Chinese companies and financiers when operating overseas, including the China Banking Regulatory Commission’s Green Credit Guidelines²¹³ and the joint Guidelines for Environmental Protection in Foreign Investment and Cooperation, issued by China’s Ministry of Commerce and Ministry of Environmental Protection. There are also specific guidelines that apply to companies engaged in overseas mining and forestry projects. However, none of these standards include mechanisms for enforcement, and it is

²¹³ For an analysis of the Green Credit Guidelines see: Friends of the Earth US (2015), *Going Out, But Going Green? Assessing the Implementation of China’s Green Credit Guidelines Overseas*, Washington DC: FOE. <http://www.foe.org/news/archives/2014-11-going-out-but-going-green>.

unclear to what extent Chinese companies are actually implementing them in practice.²¹⁴

Strong social and environmental safeguards are essential to any successful development finance institution. Governance challenges are present in many ASEAN countries, and several have poor track records for managing social and environmental impacts of development projects, and have been implicated in forced evictions and displacement of communities from their homes, lands and territories. In a context of weak rule of law and justice systems, vulnerable people and fragile ecosystems depend on the protections afforded by strong operational policies of financiers, which bear responsibility for the impacts of the projects that they fund. Chinese actors are no exception, and unless they develop their standards and accountability systems quickly, they risk finding themselves embroiled in social conflicts and implicated in environmental disasters across the region.

The Response of Other Nations and Institutions

The establishment of the AIIB and the rapid development of other China-led initiatives has clearly raised concerns among some nations that are anxious about China's increasing role and influence in regional and global finance. The United States opted out of joining the AIIB, as did Japan, which subsequently announced several of its own initiatives to fund infrastructure in the region. For example, as AIIB members met in May 2015 for a chief negotiators meeting in Singapore, Japanese Prime Minister Shinzo Abe announced that Tokyo would make US\$110 billion available for infrastructure projects in Asia over the next five years.²¹⁵ This funding will go through Japanese government-affiliated bodies such as the Japan International Cooperation Agency and the Japan Bank for International Cooperation, as well as the Asian Development Bank.²¹⁶ Japan also committed over US\$6 billion in aid to the five Mekong countries specifically for infrastructure projects.²¹⁷

While the Asian Development Bank has begun to co-finance projects with the AIIB, reforms approved by the Asian Development Bank's Board in late 2015 also appear to be an attempt to stay competitive in this evolving environment. These reforms seek to make the bank "stronger, better and faster" by simplifying procurement processes and board approval procedures, while streamlining processes for loans, technical assistance and disbursement.²¹⁸ In late 2015, the Japanese prime minister also

²¹⁴ See IDI's forthcoming handbook on Chinese safeguards for a practical guide to these policies and others.

²¹⁵ Piling, D. (2015, 27 May), *A Bank Made in China and Better Than the Western Model*, Financial Times. <http://www.ft.com/cms/s/0/14c9f302-0397-11e5-a70f-00144feabdc0.html> (accessed May 2016).

²¹⁶ Agence France Presse (2015, 19 May), *Japan poised to announce US\$100 billion investment in Asian infrastructure*, South China Morning Post. <http://www.scmp.com/news/asia/east-asia/article/1802992/japan-poised-announce-us100-million-investment-infrastructure> (accessed May 2016).

²¹⁷ Harding, R. (2015, 5 July), *Japan boosts aid to 'Mekong five' nations*, Financial Times. <http://www.ft.com/cms/s/0/f63f3acc-22e6-11e5-9c4e-a775d2b173ca.html> (accessed May 2016).

²¹⁸ Asian Development Bank (2015, 16 December), *Press Release: ADB Approves Reforms Package to Speed Loan Delivery, Enhance Operational Efficiency*. <http://www.adb.org/news/adb-approves-reforms-package-speed-loan-delivery-enhance-operational-efficiency> (accessed May 2016).

announced that the country would halve the time that it takes to approve yen-denominated development loans and make it easier for borrowers to receive loans.²¹⁹

The World Bank, meanwhile, is overhauling its social and environmental safeguard policies, with a proposal to drastically reduce front-end requirements, such as the preparation of full resettlement plans, prior to project consideration by the board.²²⁰ A goal of the World Bank's proposed Environmental and Social Framework is to streamline the preparation and appraisal process to make it easier, cheaper and quicker to approve projects.

Inclusive Development International and many other civil society groups have argued that the World Bank's proposed reforms do away with essential front-end analysis, such as assessing the extent of displacement and other impacts and whether or not mitigation measures are technically and economically feasible *before* a project is approved.²²¹ If adopted, these dilutions would pose a serious risk to project-affected people for the sake of expediting loans and making the World Bank a more competitive player in global development finance. Although these reforms began in 2012, prior to the establishment of the AIIB, the shift towards a more expeditious lending model is in part motivated by the desire to be more competitive with emerging economy development financiers.

The emergence of the AIIB and other new actors in development finance has, to varying degrees, sparked a spate of reforms at established development finance institutions in an effort to remodel themselves as more attractive lenders. While reforms that promote bureaucratic efficiency are welcome, development banks must not enter into a race to the bottom with respect to environmental and social safeguards and sacrifice the interests of the poor in order to compete for a share of the development finance market. Rather, if new players such as the AIIB hope to be taken seriously as credible multilateral financial institutions, they should aim to lift the bar by incorporating the latest research, know-how and technology into their social and environmental safeguards systems. China's own extensive internal experience on issues including resettlement and clean energy technology should be drawn upon and reflected in its development finance institutions and investment strategies.

The Development of China's Role in the ASEAN Region

China's relationship with some ASEAN nations is complicated by the existence of unresolved territorial disputes. At the same time, President Xi Jinping is eager to promote the concept of the "China-ASEAN Community of Common Destiny." The AIIB, One Belt One Road and other financial initiatives are seen as a means to improve economic and diplomatic cooperation with the regional association. China's foreign direct investment in ASEAN is growing each year, and according to China's official

²¹⁹ Japan Times (2015, 21 November), *Abe offers ASEAN easier yen loans to counter Beijing's moves*, Japan Times Online. <http://www.japantimes.co.jp/news/2015/11/21/national/southeast-asia-set-launch-unified-economic-community/> (accessed May 2016).

²²⁰ World Bank (2014, 2 September), *Review and Update of the World Bank's Safeguard Policies, Proposed Environmental and Social Framework, Background Paper*, paragraph 20.

²²¹ See IDI's reports, press releases and submissions to the World Bank: <http://www.inclusivedevelopment.net/world-bank-safeguards-campaign/>.

statistics, official investment flows reached almost US\$7.8 billion in 2014.²²² ASEAN is of crucial importance to the AIIB and One Belt One Road. All 10 members are also members of the AIIB, and the One Belt One Road passes directly through ASEAN.

Numerous leaders and senior officials from ASEAN countries have publicly promoted the potential benefits of the AIIB and the One Belt One Road initiative for their own nations. In particular, regional integration is seen as a key priority and a likely target for infrastructure financing in the coming years. Within the framework of Greater Mekong Subregion cooperation, various institutions seek to support the implementation of projects in areas including transport, energy, telecommunications, agriculture, trade and private sector investment.²²³ Project pipelines are developed by individual nations and financed by various institutions, including the World Bank and Asian Development Bank, but also Chinese policy banks and other investors. The multilateral AIIB, Chinese policy and commercial banks, and investment funds are all likely to support projects supporting integration of the region in the coming years.

The institutions and initiatives discussed here could potentially prompt an influx of capital to the region, supporting a more rapid roll-out of regional infrastructure investment, and contributing to enhanced connectivity. At the same time, without adequate transparency, safeguards and oversight, the benefits will be offset by negative impacts on people and the environment. Civil society groups can play an important role in monitoring and engaging with these new developments, as elaborated in the final section of this paper.

²²² Ministry of Commerce of the People's Republic of China et al (2015), *2014 Statistical Bulletin of China's Outward Foreign Direct Investment*, Beijing: China Statistics Press, p.116.

²²³ Asian Development Bank (no date), *GMS Overview*. <http://www.adb.org/countries/gms/overview> (accessed May 2016).

The Growth of Chinese Overseas Finance and Investment: Opportunities for Civil Society to Respond

This paper was developed in order to shed light on recent developments regarding Chinese overseas infrastructure financing and to promote discussion on the potential implications that this may have for the ASEAN region and beyond. The nature of the institutions and initiatives presented in this paper differ considerably. For example, although led by China, the AIIB is a multilateral institution with a broad membership from Asia and elsewhere. Although civil society consultation by the bank has so far been lacking, the multilateral nature of the bank presents potential opportunities for civil society to engage and influence. In contrast, the One Belt One Road is not an institution, it is an initiative to promote a comprehensive government strategy, and therefore there is no central entity coordinating its implementation on the ground.

The Chinese investment funds discussed here are wholly run by China. While they are usually not visible on the ground, basic information is available on their websites regarding their investments, and there may be opportunities to engage with these institutions in the future. This is especially true of the China-ASEAN Investment Cooperation Fund, which has an environmental and social management system and guidelines that adopt the Performance Standards on Environmental and Social Sustainability of the International Finance Corporation. Finally, China's policy banks, the China Development Bank and Eximbank, have been active overseas for over a decade, but are generally difficult to approach and have not tended to respond to attempts at engagement by civil society. However, these banks will continue to be important players in Chinese outbound investment, and it is crucial that civil society groups develop their understanding of these actors and strategies for engaging and influencing them.

During the process of researching this paper, Inclusive Development International consulted with partners and peers from across the Asia Region and recorded their hopes and concerns regarding trends in Chinese finance in the countries where they live and work. A workshop was held in Cambodia in November 2015, at which the preliminary findings of this study were presented. Participants identified the importance of improved connectivity and infrastructure development in the region, but stressed that such investment must be responsive to the needs and desires of local people, and implemented in a manner that is transparent, responsible and accountable. Participants raised common concerns, including:

- Lack of access to information about the development of new institutions.
- Limited disclosure and transparency by Chinese financial institutions in general.
- Weaknesses in safeguards and poor consultation with civil society by the AIIB.
- Lack of clarity on grievance and oversight mechanisms.
- Potential environmental impacts and displacement associated with new projects.
- Food and water security issues connected to impending mega-projects.
- Lack of understanding of the power dynamics between different AIIB members.
- Lack of certainty on how to engage Chinese-led financial institutions.
- Lack of clarity on the entry points available to approach the AIIB and other institutions.

Despite these challenges, there are also opportunities for civil society groups to engage and advocate for more responsible infrastructure investment from China. This is not an easy task, but the following actions may prove useful to civil society groups operating in regions with high levels of Chinese investment:

- **Develop a stronger understanding of Chinese financial institutions and approaches:** This paper seeks to provide information and background on the development of several new Chinese-led financial institutions. As these institutions develop and their operations grow, it is important that civil society groups expand their knowledge and understanding of their governance structures, strategies and operations.
- **Develop knowledge of country-level and regional infrastructure development plans:** Multilateral and bilateral financing for infrastructure projects often comes in response to requests from host-country governments. Countries will have their own pipeline of projects for which they will seek financing. By gathering information on these pipelines, it may be possible to predict which projects are coming next and which ones are likely to attract Chinese financing.
- **Monitor the institutional development and future activities of AIIB:** The AIIB has now been launched but is still in its early stages. Therefore, it is important to monitor its institutional development and the implementation of recently adopted and in-progress operational policies, handling of information disclosure, and establishment of a grievance mechanisms procedure. Likewise, its process for project approval should be monitored in order to identify opportunities for influencing decision-making.
- **Monitor activities of investment funds:** The Silk Road Fund and the China-ASEAN Investment Cooperation Fund are already active in the ASEAN region. It is important to monitor their operations throughout the region as they expand. Both have websites that can be useful sources of information, including on new projects and investments. The information on these sites is basic, however, so it is also important to monitor media reports and other sources for information on proposed projects.
- **Raise community awareness:** If you know of or work with communities that are likely to be impacted by activities financed by the institutions covered in this paper, it is important to raise their awareness and understanding of these actors, and what options may be available to them to influence the projects and seek accountability and recourse if they suffer harm. This paper is accompanied by several simplified factsheets that can be translated into local languages and used as a tool when working with grassroots groups and communities.
- **Engage Chinese financial institutions:** All of the institutions profiled in this paper claim to adhere to principles of sustainable development – a key element of which is public consultation. Civil society groups can seek to engage the institutions to request information and provide input regarding institutional and policy development, as well as to try to influence individual projects. Even though the institutions mentioned here do not yet have formal grievance

mechanisms, affected people can send letters to the institutions setting out concerns or evidence of harms, referring to applicable guidelines and standards, including international human rights standards, and pointing out the responsibility of financiers for the social, environmental and human rights impacts of projects that they support.

- **Advocate for improved standards and implementation:** The AIIB's Environmental and Social Framework is now adopted, and the window for influencing its development has closed. However, it will be revisited and revised after three years, which could potentially present an opportunity for civil society to re-engage in the drafting process. The Chinese banks and funds discussed here have social and environmental guidelines of varying quality, but the extent to which they are implemented is unclear. Civil society groups can campaign for these guidelines to be expanded, improved, published and implemented. A key area in which civil society can influence these processes is by monitoring and exposing problematic projects and calling for strong safeguards to prevent similar harms occurring in the future.
- **Advocating for improved transparency:** With the exception of the AIIB, none of the institutions covered by this paper have made detailed project information available online. Civil society groups can lobby institutions for improved information disclosure. A simple way to make this a reality is by developing better websites that are user-friendly and contain links to detailed project documentation. Financial institutions should also establish strong information disclosure policies and request mechanisms.
- **Advocate with international financial institutions collaborating with the AIIB:** The AIIB has begun to co-finance projects with other international financial institutions, including the Asian Development Bank, European Bank for Reconstruction and Development, and World Bank. The Asian Development Bank has stated that its own safeguards must be applied in such co-financing arrangements. It will be important to closely monitor these projects and engage with both the AIIB and co-financing institution to raise concerns, request information and ensure that safeguards are implemented properly. Co-financing creates an important entry point to influence the operations and practices of the AIIB by using the engagement platforms and accountability mechanisms provided by co-financiers.
- **Develop information-sharing networks:** The institutions covered by this paper are complex and operate in dozens of countries in Asia and around the world. For this reason, it is important for civil society groups to regularly share information and experiences with partners and peers at the national, regional and international level.



Artisinal mining at mining dumps close to copper mines operated by subsidiaries of Wanbao Mining in Monywa, Myanmar (Photo by Xie Wenhong)

Little more than a decade ago, China was a relatively minor actor in global investment and finance. By 2014 China had become the second largest global investor, second only to the United States. Outbound investment has been made possible due to strong backing from the Chinese state and financing from its policy and commercial banks. In recent years, China has promoted the establishment of new financial institutions and initiatives, including the multilateral Asian Infrastructure Investment Bank (AIIB). China has also established investment funds such as the Silk Road Fund to provide further capital for outbound investment. These new institutions and initiatives focus heavily on infrastructure development, and with support from its One Belt One Road initiative, China is set to expand its role in global infrastructure financing significantly in the coming years.



This paper seeks to increase public awareness of these institutions and initiatives, how they will potentially impact on local communities and the environment, and what environmental and social standards and governance systems they have adopted. It also discusses strategies that civil society groups could deploy to respond to these developments and influence the policies, projects and operations of Chinese-led finance institutions.

